

Linear Guide



1-1 Features of tbmotion Linear Guide.....	A02
1-2 The Procedure of Select Linear Guide.....	A05
1-3 Basic Load Rating and Service Life of Linear Guide.....	A06
1-4 Friction.....	A13
1-5 Working Load.....	A14
1-6 Safety Factor and Load.....	A20
1-7 Calculation of Average Working Load.....	A28
1-8 Calculation Example.....	A32
1-9 Accuracy.....	A40
1-10 Predicting the Rigidity.....	A42
1-11 Installation of Linear Guide.....	A44
1-11-1 Datum Representation.....	A44
1-11-2 Recognizing of Master Rail.....	A45
1-11-3 For Butt-joint Rail.....	A46
1-11-4 Mounting Methods.....	A47
1-11-5 Common Fastening Method of Linear Guide.....	A48
1-11-6 Mounting the Linear Guide.....	A49
1-12 Lubrication.....	A56
1-13 Precautions of Linear Guide.....	A57
2-1 The Types of TBI MOTION Linear Guide.....	A58
2-2 TRH / TRS / TRC International Standard Linear Guide.....	A59
2-2-3 TR-Series.....	A60
2-2-4 Nominal Model Code for Non-interchangeable TR Type.....	A61
2-2-5 Nominal Model Code for Interchangeable TR Type.....	A62
2-2-6 The Standard Length and Maxima Length of Linear Rail.....	A72
2-2-7 Mounting Type of Linear Rail.....	A72
2-2-8 Accuracy Standard.....	A74
2-2-9 Determining the Magnitude of a Preload.....	A76
2-2-10 Mounting Location of Grease Nipples.....	A77
2-2-11 Grease Nipples.....	A78
2-2-12 J-Flow System.....	A80
2-2-13 Strong Dust-proof/Self-Lubricating Linear Guide Series Accessory.....	A81
2-2-14 Dust-proof/Accessory.....	A86
2-2-15 Friction.....	A91
2-2-16 Mounting-Surface Dimensional Tolerance.....	A92
2-3 TM Miniature Linear Guide.....	A93
2-3-1 The Characteristics of TM Series.....	A93
2-3-2 The Structure of TM-series.....	A94
2-3-3 Accuracy.....	A94
2-3-4 Preload.....	A95
2-3-5 Types of Lubrication.....	A96
2-3-6 Order Information.....	A96
2-3-7 Nominal Model Code of TM Type.....	A98

ABOUT LINEAR GUIDE

1-1 Features of *TBI MOTION* Linear Guide

■ 1-1-1 High Accuracy

Linear Guide has little friction, only a small driving force is needed to move the load. Low friction helps the temperature rising effect to stay low. Thus, the friction is decreased and the accuracy can be maintained for a long period than tradition slide system.

■ 1-1-2 High Rigidity

The design of Linear Guide features an equal load rating in all directions that provide sufficient rigidity load in all directions, self-aligning capability to absorb installation-error. Moreover, a sufficient preload can be achieved to increase rigidity and makes it suitable for any kind of installation.

■ 1-1-3 Easy for Maintenance

Compared with high-skill required scrapping process of traditional slide system, the Linear Guide can offer high precision even if the mounting surface is machined by milling or grinding. Moreover, the interchangeability of Linear Guide gives a convenience for installation and future maintenance.

■ 1-1-4 High Speed

Linear Guide block, rail and ball apply by contact point of rolling system. Due to the characteristic of low friction, the required driving force is much lower than that in other systems, thus the power consumption is low. Moreover the temperature rising effect is lower even under high speed operation.

■ 1-1-5 High Mechanical Efficiency without Clearance

Table 1.1.1

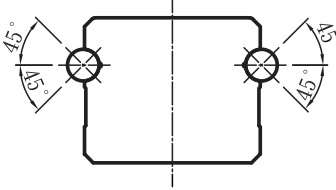
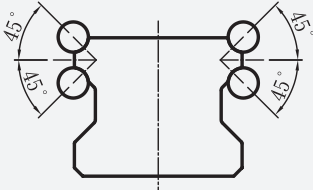
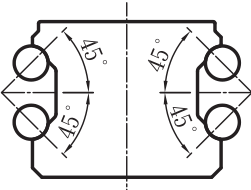
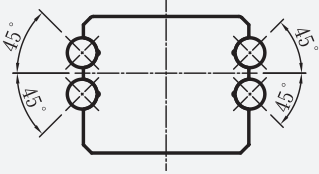
Drawing	Characteristics, Performance
	<ul style="list-style-type: none"> ● Two trains of balls. ● In a Gothic-arch groove, each ball contacts the raceway at four points 45°- 45°. ● It has constant contact point between ball and arc groove. ● Rigidity has high stability. ● Two-row design is able to perform an equal load rating in four directions.
	<ul style="list-style-type: none"> ● Four trains of balls. ● The circular-arc groove has two contact points at 45°- 45°(DF)-Four-Row Design features an equal load rating in all four directions with high rigidity. ● Four-row design is able to perform an equal load rating in four directions. ● Self-Aligning to absorb installation-error.
	<ul style="list-style-type: none"> ● Four trains of balls. ● The circular-arc groove has two contact points at 45°- 45° (DB). ● Four-Row Design features an equal load rating in all four directions with high rigidity. ● Low friction promotes smooth operating condition.
	<ul style="list-style-type: none"> ● Four trains of balls. ● In the Gothic-arch groove, each ball contacts the raceway at two points 45°- 45°, Light preload, two contact points, Heavy preload, four contact points. ● Compared with traditional DB type, it has higher rigidity.

ABOUT LINEAR GUIDE

1-1 Features of *TBI MOTION* Linear Guide

The Contract table of four-row design with equal load rating and two-row Gothic design.

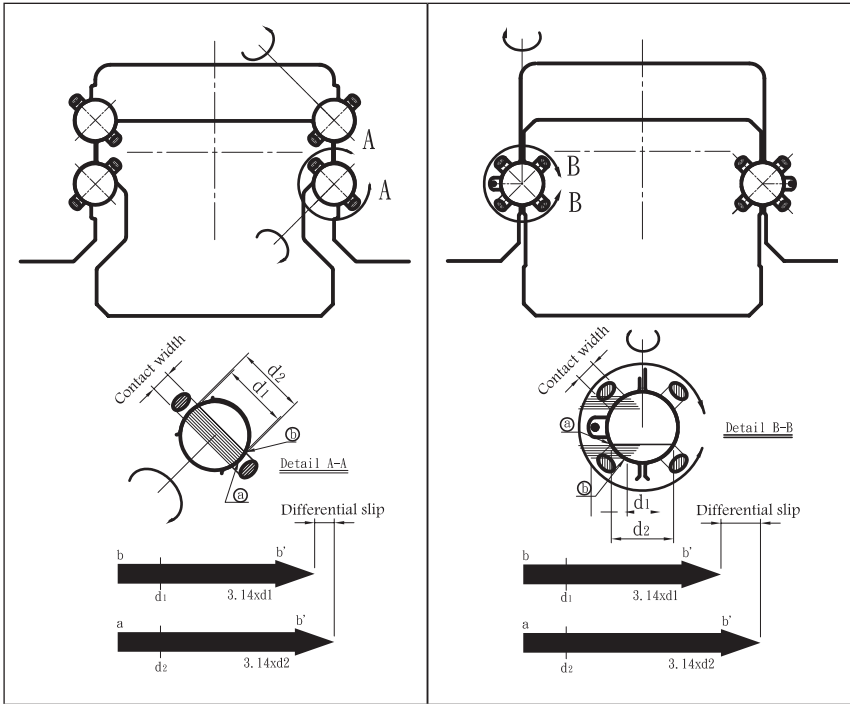

Fig 1.1.1 Four-Row Equal Load Rating Design

Fig 1.1.2 Four-Row Equal Load Rating Design

As shown in the diagram, the difference between inner surface circumference(πd_1) and outer surface circumference(πd_2) which is the contact point of ball, it is the slip that will occur while the ball rolling, this is called differential slip. If the differential slip is larger, the ball will rotate while rolling, increasing the friction coefficient and friction resistance. Under the condition with preload and loading, due to the two point of contact the difference between d_1 and d_2 is little, the differential slip is little as well, the smoothness of rolling can be achieved and thus increase efficiency.

1-2 The Procedure of Select Linear Guide

1-2-1 Flowchart

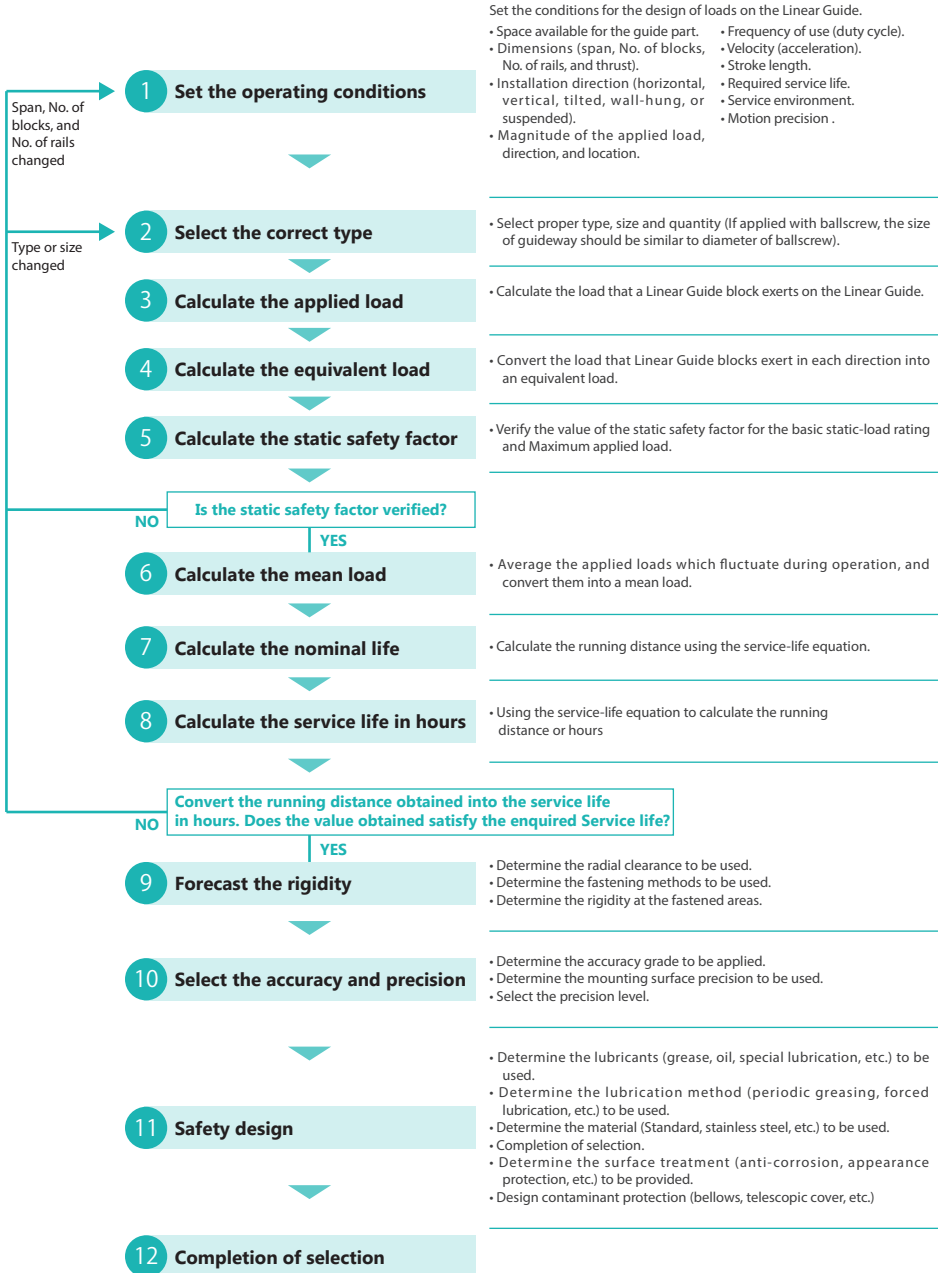

ABOUT LINEAR GUIDE

1-3 Basic Load Rating and Service Life of Linear Guide

When determining a model that would suit your service conditions for a linear motion system, the load carrying capacity and service life of the model must be considered. To consider the load carrying capacity you should know the static safety factor of the model calculation based on the basic static load rating. Service life can be assessed by calculating the nominal life based on the basic dynamic load rating and checking to see if the obtained value meet your requirements.

The service life of a linear motion system refers to the total running distance that the linear motion system travels until flaking (the disintegration of a metal surface in scale-like pieces) occurs there to as a result of the rolling fatigue of the material caused by repeated stress on raceways and rolling elements.

Basic Load Rating : There are two basic load ratings for linear motion systems : basic static load rating (C_0), which sets the static permissible limits, and basic dynamic load rating (C).

■ 1-3-1 Basic Static Load Rating (C_0)

If a linear motion system, whether at rest or in motion, receives an excessive load or a large impact, a localized permanent set develops between the raceway and rolling elements. If the magnitude of the permanent set exceeds a certain limit, it hinders the smoothness of the motion system.

The basic static load rating refers to a static load in a given direction with given magnitude such that the sum of the permanent set of the rolling elements and that of the raceway at the contact area under the most stress is 0.0001 times greater than the rolling element diameter.

In linear motion systems, the basic static load rating is defined as the radial load. Thus the basic static load rating provides a limit on the static permissible load.

■ 1-3-2 Basic Permissible Moment (M_x , M_y , M_z)

When a Linear Guide gets a force that makes the balls distorted to 1/10,000 of their diameter, we call the force as basic static permissible moment. Values of M_x , M_y , M_z are shown on Fig 1.3.1, which suggest 3 axis of moment on a Linear Guide slide.

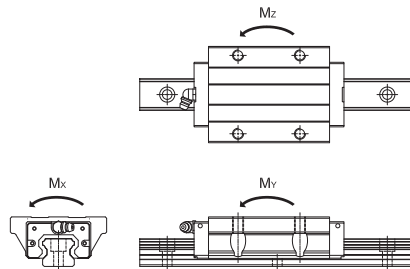

Fig 1.3.1

■ 1-3-3 Static Safety Factor f_s

$$f_s = \frac{C_o}{P} \text{ or } \frac{M_o}{M}$$

f_s : static safety factor
 C_o : basic static load rating (N)
 M_o : static permissible moment (N-mm)
 P : calculated load (N)
 M : calculated moment (N-mm)

A linear motion system may possibly receive an unpredictable external force due to vibration and impact while it is at rest or is moving or due to inertia resulting from start and stop. It is therefore necessary to consider the static safety factor against operating loads like these. The static safety factor (f_s) indicates the ratio of a linear motion system load carrying capacity 【basic static load rating C_o 】 to the load exerted there on.

To calculate the applied load on Linear Guide, mean load and static safety factor must be obtained in advance. In the working environment with high intensity while start and stop, cantilever or cutting, a unexpected heavy load may occurs, therefore the maximum load must be acquired. Datum values of static safety factor are shown below;

Table 1.3.1 Static Safety Factor f_s

Machine Used	Loading Conditions	f_s lower limit
Ordinary Industrial Machine	Receives no vibration or impact	1.0-1.3
	Receives vibration and impact	2.0-3.0
Machine Tool	Receives no vibration or impact	1.0-1.5
	Receives vibration and impact	2.5-7.0

For large radial loads	$\frac{f_h \cdot f_t \cdot f_c \cdot C_o}{P_R} \geq f_s$
For large reverse-radial loads	$\frac{f_h \cdot f_t \cdot f_c \cdot C_{oL}}{P_L} \geq f_s$
For large lateral loads	$\frac{f_h \cdot f_t \cdot f_c \cdot C_{oT}}{P_T} \geq f_s$

f_s : Static safety factor
 C_o : Basic static-load rating (radial) (N)
 C_{oL} : Basic static-load rating (reverse-radial) (N)
 C_{oT} : Basic static-load rating (lateral) (N)
 P_R : Calculated load (radial) (N)
 P_L : Calculated load (reverse-radial) (N)
 P_T : Calculated load (lateral) (N)
 f_h : Hardness factor (Fig1.3.2)
 f_t : Temperature factor (Fig1.3.3)
 f_c : Contact factor (Table1.3.2)

ABOUT LINEAR GUIDE

1-3 Basic Load Rating and Service Life of Linear Guide

■ 1-3-4 Service Life (L)

Even when identical linear guideways in a group are manufactured in the same way or applied under the same condition, the service life may be varied. Thus, the service life is used as an indicator for determining the service life of a linear guideway system. The nominal life (L) is defined as the total running distance that 90% of identical linear guideways in a group, when they are applied under the same conditions, can work without developing flaking.

■ 1-3-5 Basic Dynamic Load Rating (C)

Basic dynamic load rating (C) can be used to calculate the service life when linear guideway system response to a load. The basic dynamic load rating (C) is defined as a load in a given direction and with a given magnitude that when a group of linear guideways operate under the same conditions. As the rolling element is a ball, the nominal life of the linear guideway is 50 km. Moreover, as the rolling element is a roller, the nominal life is 100 km.

■ 1-3-6 Calculation of Nominal Life

The service lives of linear motion system more or less various from system to system even if they are manufactured to the same specifications and remain in service under the same operating conditions. Hence, a guideline for determining the service life of a linear motion system is based on nominal life, which is defined as follows. The nominal life refers to the total running distance that 90% of identical linear motion systems in a group, when interlocked with one another under the same conditions, can achieve without developing flaking. The nominal life (L) of a linear motion system can be obtained from the basic dynamic load rating (C) and load imposed (P_c) using the following equations.

For a linear motion system with balls

$$L = \left(\frac{f_h \cdot f_t \cdot f_c}{f_w} \cdot \frac{C}{P_c} \right)^3 \cdot 50$$

For a linear motion system with rollers

$$L = \left(\frac{f_h \cdot f_t \cdot f_c}{f_w} \cdot \frac{C}{P_c} \right)^{\frac{10}{3}} \cdot 100$$

Service-Life Equation

The service life of the Linear Guide can be obtained using the following equation :

$$L = \left(\frac{f_h \cdot f_t \cdot f_c}{f_w} \cdot \frac{C}{P_c} \right)^3 \cdot 50 \text{ km}$$

(total distance that can be traveled by at least 90% of a group of Linear Guide operated under the same conditions)

C : basic dynamic-load rating (N)
 P_c : calculated load (N)
 f_h : hardness factor (Fig 1.3.2)
 f_t : temperature factor (Fig 1.3.3)
 f_c : contact factor (Table 1.3.2)
 f_w : load factor(N) (Table 1.3.3)

(Once nominal life (L) is obtained using this equation. The Linear Guide service life can be calculated by using the following equation if the stroke length and the number of reciprocating cycles are constant)

$$L_h = \frac{L \cdot 10^6}{2 \cdot l_s \cdot N_1 \cdot 60}$$

L_h : service life in hours (h)
 l_s : stroke length (mm)
 N₁ : No. of reciprocating cycles per min (min⁻¹)

【 f_h : Hardness factor 】

To ensure achievement of the optimum load-bearing capacity of the Linear Guide, the raceway hardness must be 58~64 HRC. At a hardness below this range, the basic dynamic and static-load ratings decrease. The ratings must therefore be multiplied by the respective hardness factors (f_h). As the Linear Guide has sufficient hardness, f_h for the Linear Guide is 1.0 unless otherwise specified.

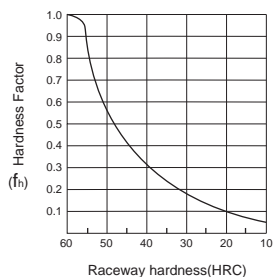

Fig 1.3.2 Hardness Factor (f_h)

【 f_t : Temperature factor 】

For Linear Guide used at ambient temperatures over 100°C, a temperature factor corresponding to the ambient temperature, selected from the diagram below, must be taken into consideration. In addition, please note that selected Linear Guide itself must be a model with high-temperature specifications.

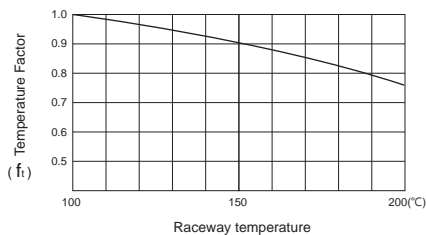

Fig 1.3.3 Temperature Factor (f_t)

※ When used at ambient temperatures higher than 80°C, the seals, end caps, and ball cages used must be changed to those with high-temperature specifications.

ABOUT LINEAR GUIDE

1-3 Basic Load Rating and Service Life of Linear Guide

【 f_c : Contact factor】

When multiple Linear Guide blocks are laid by each other, moments and mounting-surface precision will affect operation, making it difficult to achieve uniform load distribution. For Linear Guide blocks used laid over one another, multiply the basic load rating (C), (C_0) by a contact factor selected from the table below.

Table 1.3.2 Contact factor (f_c)

No. of Blocks Used	Contact Factor (f_c)
In normal use	1
2	0.81
3	0.72
4	0.66
5	0.61
6 or more	0.6

※ When the non-uniform load distribution can be predicted, as in a large system, consider using a contact factor.

【 f_w : Load factor】

In general, machines in reciprocal motion are likely to cause vibration and impact during operation, and it is particularly difficult to determine the magnitude of vibration that develops during high-speed operation as well as that of impact during repeated starting and stopping in normal use. Therefore, where the effects of speed and vibration are estimated to be significant divide the basic dynamic-load rating (C) by a load factor selected from the table below.

Table 1.3.3 Load Factor (f_w)

Vibration and Impact	Velocity(V)	f_w
Very Slight	Very Low $V \leq 0.25$ m/s	1~1.2
Slight	Low $0.25 < V \leq 1$ m/s	1.2~1.5
Moderate	Medium $1 < V \leq 2$ m/s	1.5~2
Strong	High $V > 2$ m/s	2~3.5

Calculation Examples :

Application : Machine Center

Block model number : TRH30FE

(Basic static load $C_0 = 88.329$ kN, Basic dynamic load $C = 47$ kN)

The calculated load $P_c = 2614$ N

The formula of calculating the life time by travel is

$$L = \left(\frac{f_H \cdot f_T \cdot f_c}{f_w} \cdot \frac{C}{P_c} \right)^3 \cdot 50 \text{ km}$$

Since using only one block in this application, we take $f_c = 1$

Supposed the speed is not very high between 0.25~1 m/s, so we take $f_w = 1.5$

The temperature of working environment is under 100°C. The temperature factor $f_t = 1$

The hardness of raceway is 58~64 HRC, so the hardness $f_H = 1$

With all above data, the life time by travel of this application $L = 86,112$ km

To calculate the life time by using hours :

We supposed the distance of travel $L_s = 3000$ mm

Times (Back and forth) per mins $N1 = 4$ (min^{-1})

The life time by travel is 86,112 km, the distance of travel is 3 m (3000mm), so each back and forth is 6 m.

The total times of back and forth would be $86,112 \times 1000/6 = 14,352,000$

The life time by using minutes is $14,352,000/4 = 3,588,000$ mins = 59,800 hours

■ 1-3-7 Service-Life Equation L_h

The Service Life can be calculated by operating term and velocity Nominal Life.

$$L_h = \left(\frac{L \cdot 10^3}{V_e \cdot 60} \right) = \frac{\left(\frac{C}{P} \right)^3 \cdot 50 \cdot 10^3}{V_e \cdot 60} \cdot \text{hr}$$

L_h : Service Life in Hour L : Nominal life (km)

V_e : Velocity (m/min) C/P : Load Ratio

Calculating Life Time

Formula (A) calculating hour

L_n : Lifetime (h)
 L : Nominal life (km)
 L_s : Distance of travel (mm)
 N_1 : Times of travel per minute (min^{-1})

$$L_n = \frac{L \cdot 10^6}{2 \cdot L_s \cdot N_1 \cdot 60}$$

Formula (B) calculating year

L_y : Lifetime (year)
 L : Nominal life (km)
 L_s : Distance of travel (mm)
 N_1 : Times of travel per minute (min^{-1})
 M_n : Minutes of running per day (min/hr)
 H_n : Hours of running per day (hr/day)
 D_n : Days of running per year (day/year)

$$L_y = \frac{L \cdot 10^6}{2 \cdot L_s \cdot N_1 \cdot M_n \cdot H_n \cdot D_n}$$

Notes : The service life is verified by different environments and other usage conditions. Please confirm this information with the customer. For environment factors, please refer to page A08~A10.

ABOUT LINEAR GUIDE

1-3 Basic Load Rating and Service Life of Linear Guide

Example 1 :

There is a working station using linear guides with a nominal life of 45000 km, how should we calculate its service life in hours.

Known :

L_s : Distance of travel = 3000 mm (mm)

N_1 : 4 times of travel per minute (min^{-1})

$$L_n = \frac{L \cdot 10^6}{2 \cdot L_s \cdot N_1 \cdot 60} = \frac{45000 \cdot 10^6}{2 \cdot 3000 \cdot 4 \cdot 60} = 31250 \text{ hr}$$

Example 2 :

There is a working station using linear guides with a nominal life 71231.5 km, how should we calculate its service life in year.

Known :

L_s : Distance of travel = 4000 mm (mm)

N_1 : 5 times of travel per minute (min^{-1})

M_s : Running 60 mins per hour (min/hr)

H_s : Running 24 hours per day (hr/day)

D_s : Running 360 days per year (day/year)

$$L_y = \frac{L \cdot 10^6}{2 \cdot L_s \cdot N_1 \cdot M_s \cdot H_s \cdot D_s} = \frac{71231.5 \cdot 10^6}{2 \cdot 4000 \cdot 5 \cdot 60 \cdot 24 \cdot 360} = 3.435 \text{ year}$$

1-4 Friction

The construction of Linear Guide are block, rail and motion system which has rolling elements, such as balls and rollers, placed between two raceways. The rolling motion that rolling elements give rise to reduce the frictional resistance to 1/20 th to 1/40 th of that in a slide guide. Static friction, in particular, is much lower in a linear motion system than in other system, and there is little difference between static and dynamic friction, so that stick-slip does not occur. Therefore, Linear Guide could apply in various precision motion system. Frictional resistance in a linear motion system varies with the type of linear motion system, the magnitude of the preload, the viscosity resistance of the lubricant used the load exerted on the system, and other factors. Table shows Friction of Linear Guide.

Table 1.4.1 Friction Coefficient μ of Various Linear Motion Systems μ

Type of Linear Motion System	Friction Coefficient
Linear Guide	0.002~0.003
Ball Spline	0.002~0.003
Linear Guide Roller	0.0050~0.010
Cross Roller Guide	0.0010~0.0025
Linear Ball Slide	0.0006~0.0012

ABOUT LINEAR GUIDE

1-5 Working Load

■ 1-5-1 Working Load

The load applied to the Linear Guide, varies with the external force exerted thereon, such as the location of the center of gravity of an object been moved, the location of the thrust developed, inertia due to acceleration and deceleration during starting and stopping, and the machining resistance. To select the correct type of Linear Guide, the magnitude of applied loads must be determined in consideration of the above conditions to calculate accurate applied load.

To obtain the magnitude of an applied load and the service life in hours, the operating conditions of the Linear Guide system must first be set.

- (1) Mass : m (kg)
- (2) Direction of the action load
- (3) Location of the action point
(e.g., center of gravity) : L_2, L_3, h_1 (mm)
- (4) Location of the thrust developed : L_4, h_2 (mm)
- (5) Linear Guide system arrangement : L_0, L_1 (mm)
- (6) Velocity diagram
- (7) Duty cycle (No. of reciprocating cycles per min) : N_1 (min^{-1})
- (8) Stroke length : L (mm)
- (9) Mean velocity : V_m (mm/s)
- (10) Required service life in hours : L_h (h)

Velocity : V (mm/s)

Time constant : t_n (s)

Acceleration : a_n (mm/s^2)

$$a_n = \left(\frac{V}{t_n} \right)$$

Gravitational acceleration $g = 9.8 \text{ m/s}^2$

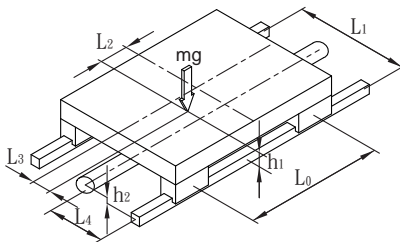

Fig 1.5.1

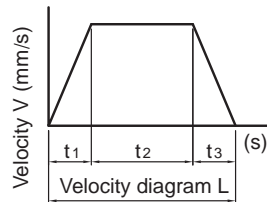

Fig 1.5.2

Calculating the Working Load

The load applied to the Linear Guide varies with the external force exerted thereon, such as the location of the center of gravity of an object being moved, the location of the thrust developed, inertia due to acceleration and deceleration during starting and stopping, and the machining resistance. To select the correct type of Linear Guide, the magnitude of applied loads must be determined in consideration of the above conditions. Using the following Table 1.5.1, we will now calculate the loads applied to the Linear Guide.

m : Mass	(kg)	g : Gravitational acceleration	(m/s^2)
L_n : Distance	(mm)	($g=9.8m/s^2$)	
F_n : External force	(N)	V : Velocity	(m/s)
P_n : Applied load	(N)	t_n : Time constant	(s)
(radial and reverse-radial directions)		a_n : Acceleration	(m/s^2)
P_{NT} : Applied load	(N)	$a_n = \left(\frac{V}{t_n} \right)$	

Table 1.5.1 Calculation Load

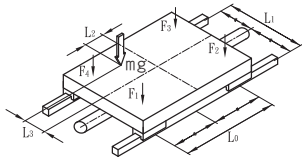
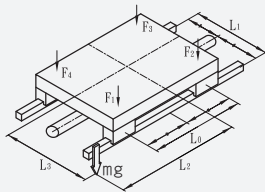
No.	Operating Conditions	Equation for Calculating Applied Load
1	Install in a horizontal position. (Move the block) Measure in uniform motion or at rest. 	$F_1 = \frac{mg}{4} + \frac{mg \cdot L_2}{2 \cdot L_0} - \frac{mg \cdot L_3}{2 \cdot L_1}$ $F_2 = \frac{mg}{4} - \frac{mg \cdot L_2}{2 \cdot L_0} - \frac{mg \cdot L_3}{2 \cdot L_1}$ $F_3 = \frac{mg}{4} - \frac{mg \cdot L_2}{2 \cdot L_0} + \frac{mg \cdot L_3}{2 \cdot L_1}$ $F_4 = \frac{mg}{4} + \frac{mg \cdot L_2}{2 \cdot L_0} + \frac{mg \cdot L_3}{2 \cdot L_1}$
2	Install in an overhung horizontal position. (Move the block) Measure in uniform motion or at rest. 	$F_1 = \frac{mg}{4} + \frac{mg \cdot L_2}{2 \cdot L_0} + \frac{mg \cdot L_3}{2 \cdot L_1}$ $F_2 = \frac{mg}{4} - \frac{mg \cdot L_2}{2 \cdot L_0} + \frac{mg \cdot L_3}{2 \cdot L_1}$ $F_3 = \frac{mg}{4} - \frac{mg \cdot L_2}{2 \cdot L_0} - \frac{mg \cdot L_3}{2 \cdot L_1}$ $F_4 = \frac{mg}{4} + \frac{mg \cdot L_2}{2 \cdot L_0} - \frac{mg \cdot L_3}{2 \cdot L_1}$

ABOUT LINEAR GUIDE

1-5 Working Load

A

Linear Guide

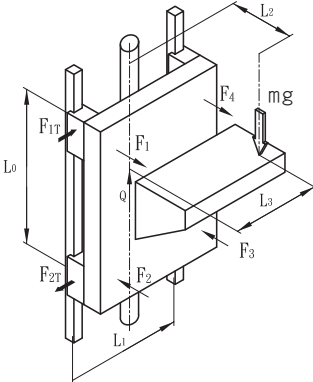
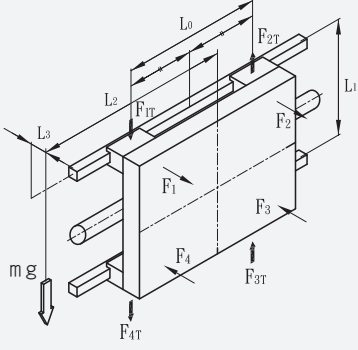
No.	Operating Conditions	Equation for Calculating Applied Load
3	<p>Install in a vertical position. Measure in uniform motion or at rest.</p>  <p>(EX) On the vertical axis of industrial robots in automatic painting machines and lifters</p>	$F_1 = F_2 = F_3 = F_4 = \frac{mg \cdot L_2}{2 \cdot L_0}$ $F_{1T} = F_{2T} = F_{3T} = F_{4T} = \frac{mg \cdot L_3}{2 \cdot L_0}$
4	<p>On a wall. Measure in uniform motion or at rest.</p>  <p>(EX) On cross rails loader travel axis</p>	$F_1 = F_2 = F_3 = F_4 = \frac{mg \cdot L_3}{2 \cdot L_1}$ $F_{1T} = F_{4T} = \frac{mg}{4} + \frac{mg \cdot L_2}{2 \cdot L_0}$ $F_{2T} = F_{3T} = \frac{mg}{4} - \frac{mg \cdot L_2}{2 \cdot L_0}$

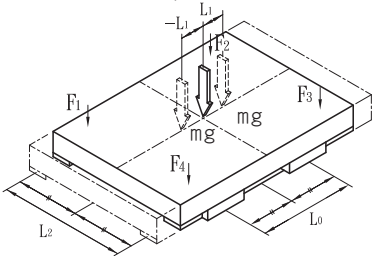
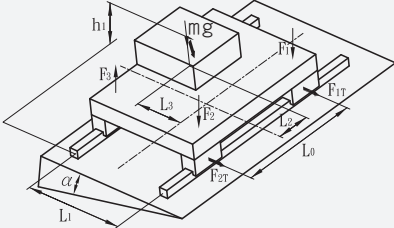
No.	Operating Conditions	Equation for Calculating Applied Load
5	<p>Move on Linear Guide rail Install in a horizontal position.</p>  <p>(EX) X - Y table/Sliding fork</p>	$F_{1\max}=F_{2\max}=F_{3\max}=F_{4\max}=\frac{mg}{4} + \frac{mg \cdot L_1}{2 \cdot L_0}$ $F_{1\min}=F_{2\min}=F_{3\min}=F_{4\min}=\frac{mg}{4} - \frac{mg \cdot L_1}{2 \cdot L_0}$
6	<p>Install in a laterally tilted position.</p>  <p>(EX) NC lathe/Carriage (for the lathe)</p>	$F_{1T} = + \frac{mg \cdot \cos\theta}{4} + \frac{mg \cdot \cos\theta \cdot L_2}{2 \cdot L_0} - \frac{mg \cdot \cos\theta \cdot L_3}{2 \cdot L_1} + \frac{mg \cdot \sin\theta \cdot h_1}{2 \cdot L_1}$ $F_{2T} = \frac{mg \cdot \sin\theta}{4} + \frac{mg \cdot \sin\theta \cdot L_2}{2 \cdot L_0}$ $F_{3T} = + \frac{mg \cdot \cos\theta}{4} - \frac{mg \cdot \cos\theta \cdot L_2}{2 \cdot L_0} + \frac{mg \cdot \cos\theta \cdot L_3}{2 \cdot L_1} - \frac{mg \cdot \sin\theta \cdot h_1}{2 \cdot L_1}$ $F_{4T} = \frac{mg \cdot \sin\theta}{4} - \frac{mg \cdot \sin\theta \cdot L_2}{2 \cdot L_0}$

ABOUT LINEAR GUIDE

1-5 Working Load

A

Linear Guide

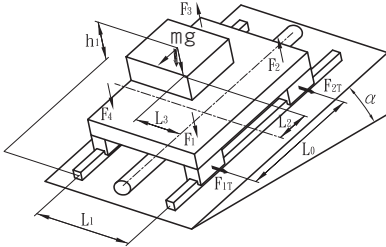
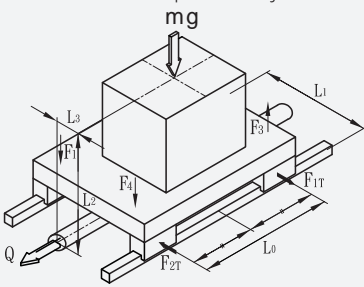
No.	Operating Conditions	Equation for Calculating Applied Load
7	<p>Install in a longitudinally tilted position.</p>  <p>(EX) NC lathe/Tool res (for the lathe)</p>	$F_{1=} + \frac{mg \cdot \cos \theta}{4} + \frac{mg \cdot \cos \theta \cdot L_2}{2 \cdot L_0}$ $- \frac{mg \cdot \cos \theta \cdot L_3}{2 \cdot L_1} + \frac{mg \cdot \sin \theta \cdot h_1}{2 \cdot L_0}$ $F_{1T=} + \frac{mg \cdot \sin \theta \cdot L_3}{2 \cdot L_0}$ $F_{2=} + \frac{mg \cdot \cos \theta}{4} - \frac{mg \cdot \cos \theta \cdot L_2}{2 \cdot L_0}$ $- \frac{mg \cdot \cos \theta \cdot L_3}{2 \cdot L_1} - \frac{mg \cdot \sin \theta \cdot h_1}{2 \cdot L_0}$ $F_{2T=} - \frac{mg \cdot \sin \theta \cdot L_3}{2 \cdot L_0}$ $F_{3=} + \frac{mg \cdot \cos \theta}{4} - \frac{mg \cdot \cos \theta \cdot L_2}{2 \cdot L_0}$ $+ \frac{mg \cdot \cos \theta \cdot L_3}{2 \cdot L_1} - \frac{mg \cdot \sin \theta \cdot h_1}{2 \cdot L_0}$ $F_{3T=} - \frac{mg \cdot \sin \theta \cdot L_3}{2 \cdot L_0}$ $F_{4=} + \frac{mg \cdot \cos \theta}{4} + \frac{mg \cdot \cos \theta \cdot L_2}{2 \cdot L_0}$ $+ \frac{mg \cdot \cos \theta \cdot L_3}{2 \cdot L_1} + \frac{mg \cdot \sin \theta \cdot h_1}{2 \cdot L_0}$ $F_{4T=} + \frac{mg \cdot \sin \theta \cdot L_3}{2 \cdot L_0}$
8	<p>Install in a horizontal position subjected to inertia.</p>  <p>(EX) Wagon Truck</p>	$F_1 = F_4 = \frac{mg}{4} - \frac{mg \cdot a_1 \cdot L_2}{2 \cdot L_0 \cdot g}$ $F_2 = F_3 = \frac{mg}{4} + \frac{mg \cdot a_1 \cdot L_2}{2 \cdot L_0 \cdot g}$ $F_{1T} = F_{2T} = F_{3T} = F_{4T} = \frac{mg \cdot a_1 \cdot L_3}{2 \cdot L_0 \cdot g}$ $F_1 = F_2 = F_3 = F_4 = \frac{mg}{4}$ $F_1 = F_4 = \frac{mg}{4} - \frac{mg \cdot a_3 \cdot L_2}{2 \cdot L_0 \cdot g}$ $F_2 = F_3 = \frac{mg}{4} + \frac{mg \cdot a_3 \cdot L_2}{2 \cdot L_0 \cdot g}$ $F_{1T} = F_{2T} = F_{3T} = F_{4T} = \frac{mg \cdot a_3 \cdot L_3}{2 \cdot L_0 \cdot g}$

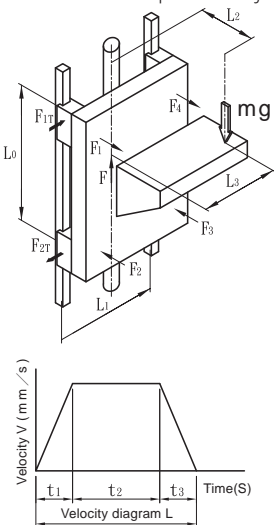
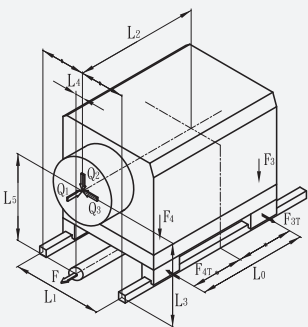
No.	Operating Conditions	Equation for Calculating Applied Load
9	<p>Mount in a vertical position subjected to inertia.</p>  <p>(EX) Elevator.</p>	$F_1 = F_2 = F_3 = F_4 = \frac{(mg + mg \cdot a_1 / g) \cdot L_2}{2 \cdot L_0}$ $F_{1T} = F_{2T} = F_{3T} = F_{4T} = \frac{(mg + mg \cdot a_1 / g) \cdot L_3}{2 \cdot L_0}$ $F_1 = F_2 = F_3 = F_4 = \frac{mg \cdot L_2}{2 \cdot L_0}$ $F_{1T} = F_{2T} = F_{3T} = F_{4T} = \frac{mg \cdot L_3}{2 \cdot L_0}$ $F_1 = F_2 = F_3 = F_4 = \frac{(mg - mg \cdot a_3 / g) \cdot L_2}{2 \cdot L_0}$ $F_{1T} = F_{2T} = F_{3T} = F_{4T} = \frac{(mg - mg \cdot a_3 / g) \cdot L_3}{2 \cdot L_0}$
10	<p>Install on a horizontal position subjected to external force.</p> 	$F_1 = F_2 = F_3 = F_4 = \frac{Q_1 \cdot L_5}{2 \cdot L_0}$ $F_{1T} = F_{2T} = F_{3T} = F_{4T} = \frac{Q_1 \cdot L_4}{2 \cdot L_0}$ $F_1 = F_4 = \frac{Q_2}{4} + \frac{Q_2 \cdot L_2}{2 \cdot L_0}$ $F_2 = F_3 = \frac{Q_2}{4} - \frac{Q_2 \cdot L_2}{2 \cdot L_0}$ $F_1 = F_2 = F_3 = F_4 = \frac{Q_3 \cdot L_3}{2 \cdot L_1}$ $F_{1T} = F_{4T} = \frac{Q_3}{4} + \frac{Q_3 \cdot L_2}{2 \cdot L_0}$ $F_{2T} = F_{3T} = \frac{Q_3}{4} - \frac{Q_3 \cdot L_2}{2 \cdot L_0}$

ABOUT LINEAR GUIDE

1-6 Safety Factor and Load

■ 1-6-1 Equivalent Factors of Linear Guide Block

Where a sufficient installation space is not available you may be obliged to use just one Linear Guide block or two Linear Guide blocks laid over one another for the Linear Guide. In such a setting, the load distribution cannot be uniform, as a result, an excessive load is exerted in localized areas (e.g., rail ends). Continued use under such conditions may result in flaking in those areas, consequently shortening the service life. In such a case, calculating true load by multiplying the moment value by any one of the moment-equivalent factors specified in Tables.

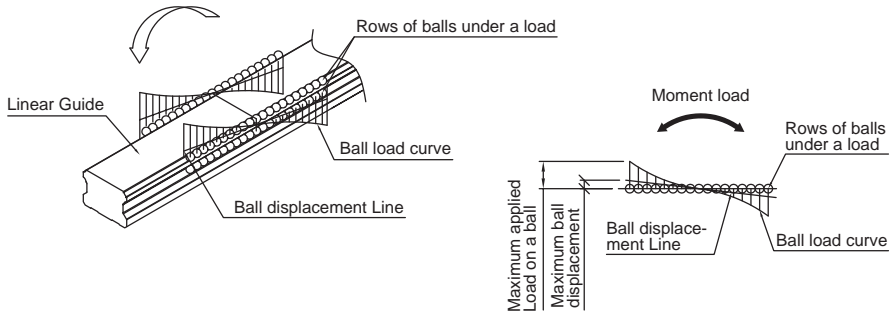

Fig 1.6.1 Ball Load Effectuated by a Moment

An equivalent-load equation applicable when a moment acts on a Linear Guides is shown below.

$$P = K \cdot M$$

P : Equivalent load per Linear Guide (kgf)

K : Equivalent moment factor (mm^{-1})

M : Developed moment (kgf · mm)

K_A , K_B , K_C represent the equivalent moment factors in directions M_A , M_B , M_C respectively.

Calculation Examples

Two Linear Guide blocks are used laid over one another.

Model No : TRH30FE

Gravitational Acceleration $g = 9.8 \text{ m/s}$

Mass $w = 5 \text{ kgf}$

$M_c = 5 \cdot 150 = 750 \text{ (kgf-mm)}$

$M_A = 5 \cdot 200 = 1000 \text{ (kgf-mm)}$

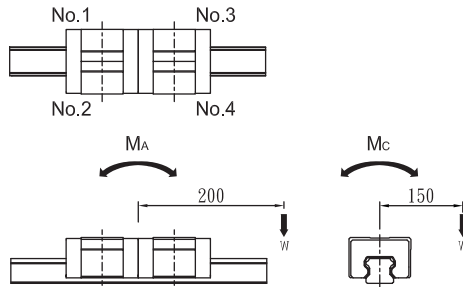

Fig 1.6.2

$$P_1 = K_c \cdot \frac{M_c}{2} + K_A \cdot M_A + \frac{W}{2} = 7.15 \cdot 10^{-2} \cdot \frac{750}{2} + 1.3 \cdot 10^{-2} \cdot 1000 + \frac{5}{2} = 42.3 \text{ (kgf)}$$

$$P_2 = -K_c \cdot \frac{M_c}{2} + K_A \cdot M_A + \frac{W}{2} = -7.15 \cdot 10^{-2} \cdot \frac{750}{2} + 1.3 \cdot 10^{-2} \cdot 1000 + \frac{5}{2} = -11.3 \text{ (kgf)}$$

$$P_3 = K_c \cdot \frac{M_c}{2} - K_A \cdot M_A + \frac{W}{2} = 7.15 \cdot 10^{-2} \cdot \frac{750}{2} - 1.3 \cdot 10^{-2} \cdot 1000 + \frac{5}{2} = 16.3 \text{ (kgf)}$$

$$P_4 = -K_c \cdot \frac{M_c}{2} - K_A \cdot M_A + \frac{W}{2} = -7.15 \cdot 10^{-2} \cdot \frac{750}{2} - 1.3 \cdot 10^{-2} \cdot 1000 + \frac{5}{2} = -37.3 \text{ (kgf)}$$

※ Note.1

Since a Linear Guide in a vertical position receives only a moment load, there is no need to apply other loads (w).

※ Note.2

In some models, load ratings differ depending on the direction of the applied load. With such a model, calculate an equivalent load in a direction in which conditions are comparably bad.

ABOUT LINEAR GUIDE

1-6 Safety Factor and Load

Table 1.6.1 TRH-V

ModelNo.	Equivalent Factors $K_a(\text{mm}^{-1})$		Equivalent Factors $K_b(\text{mm}^{-1})$		Equivalent Factors $K_c(\text{mm}^{-1})$
	Equivalent Load Calculation for a system Using One Linear Guide Block	Equivalent Load Calculation for a system Using Two Linear Guide Blocks laid Over One-Another	Equivalent Load Calculation for a system Using One Linear Guide Block	Equivalent Load Calculation for a system Using Two Linear Guide Blocks laid Over One-Another	
TRH15VN	1.48×10^{-1}	3.11×10^{-2}	1.48×10^{-1}	3.11×10^{-2}	1.34×10^{-1}
TRH15VL	1.26×10^{-1}	2.70×10^{-2}	1.26×10^{-1}	2.70×10^{-2}	1.34×10^{-1}
TRH20VN	1.11×10^{-1}	2.35×10^{-2}	1.11×10^{-1}	2.35×10^{-2}	9.90×10^{-2}
TRH20VE	8.00×10^{-2}	1.78×10^{-2}	8.00×10^{-2}	1.78×10^{-2}	9.90×10^{-2}
TRH25VN	1.04×10^{-1}	2.17×10^{-2}	1.04×10^{-1}	2.17×10^{-2}	8.62×10^{-2}
TRH25VE	7.35×10^{-2}	1.60×10^{-2}	7.35×10^{-2}	1.60×10^{-2}	8.62×10^{-2}
TRH30VN	6.52×10^{-2}	1.34×10^{-2}	6.52×10^{-2}	1.34×10^{-2}	7.69×10^{-2}
TRH30VE	6.12×10^{-2}	1.33×10^{-2}	6.12×10^{-2}	1.33×10^{-2}	7.15×10^{-2}
TRH35VN	6.95×10^{-2}	1.43×10^{-2}	6.95×10^{-2}	1.43×10^{-2}	6.29×10^{-2}
TRH35VE	5.25×10^{-2}	1.15×10^{-2}	5.25×10^{-2}	1.15×10^{-2}	5.85×10^{-2}
TRH45VL	5.80×10^{-2}	1.24×10^{-2}	5.80×10^{-2}	1.24×10^{-2}	4.38×10^{-2}
TRH45VE	4.59×10^{-2}	1.00×10^{-2}	4.59×10^{-2}	1.00×10^{-2}	4.38×10^{-2}
TRH55VL	5.25×10^{-2}	1.07×10^{-2}	5.25×10^{-2}	1.07×10^{-2}	3.78×10^{-2}
TRH55VE	4.08×10^{-2}	8.69×10^{-3}	4.08×10^{-2}	8.69×10^{-3}	3.78×10^{-2}
TRH65VL	4.52×10^{-2}	8.76×10^{-3}	4.52×10^{-2}	8.76×10^{-3}	3.24×10^{-2}
TRH65VE	3.27×10^{-2}	6.77×10^{-3}	3.27×10^{-2}	6.77×10^{-3}	3.24×10^{-2}

K_a : Equivalent moment factor in the pitching direction.

K_b : Equivalent moment factor in the yawing direction.

K_c : Equivalent moment factor in the rolling direction.

Table 1.6.2 TRH-F

Model No.	Equivalent Factors $K_a(\text{mm}^{-1})$		Equivalent Factors $K_b(\text{mm}^{-1})$		Equivalent Factors $K_c(\text{mm}^{-1})$
	Equivalent Load Calculation for a system Using One Linear Guide Block	Equivalent Load Calculation for a system Using Two Linear Guide Blocks laid Over One-Another	Equivalent Load Calculation for a system Using One Linear Guide Block	Equivalent Load Calculation for a system Using Two Linear Guide Blocks laid Over One-Another	
TRH15FN	1.48×10^{-1}	3.11×10^{-2}	1.48×10^{-1}	3.11×10^{-2}	1.34×10^{-1}
TRH15FL	1.26×10^{-1}	2.70×10^{-2}	1.26×10^{-1}	2.70×10^{-2}	1.34×10^{-1}
TRH20FN	1.11×10^{-1}	2.35×10^{-2}	1.11×10^{-1}	2.35×10^{-2}	9.90×10^{-2}
TRH20FE	8.00×10^{-2}	1.78×10^{-2}	8.00×10^{-2}	1.78×10^{-2}	9.90×10^{-2}
TRH25FN	1.04×10^{-1}	2.17×10^{-2}	1.04×10^{-1}	2.17×10^{-2}	8.62×10^{-2}
TRH25FE	7.35×10^{-2}	1.60×10^{-2}	7.35×10^{-2}	1.60×10^{-2}	8.62×10^{-2}
TRH30FN	6.52×10^{-2}	1.34×10^{-2}	6.52×10^{-2}	1.34×10^{-2}	7.69×10^{-2}
TRH30FE	6.12×10^{-2}	1.33×10^{-2}	6.12×10^{-2}	1.33×10^{-2}	7.15×10^{-2}
TRH35FN	6.95×10^{-2}	1.43×10^{-2}	6.95×10^{-2}	1.43×10^{-2}	6.29×10^{-2}
TRH35FE	5.25×10^{-2}	1.15×10^{-2}	5.25×10^{-2}	1.15×10^{-2}	5.85×10^{-2}
TRH45FL	5.80×10^{-2}	1.24×10^{-2}	5.80×10^{-2}	1.24×10^{-2}	4.38×10^{-2}
TRH45FE	4.59×10^{-2}	1.00×10^{-2}	4.59×10^{-2}	1.00×10^{-2}	4.38×10^{-2}
TRH55FL	5.25×10^{-2}	1.07×10^{-2}	5.25×10^{-2}	1.07×10^{-2}	3.78×10^{-2}
TRH55FE	4.08×10^{-2}	8.69×10^{-3}	4.08×10^{-2}	8.69×10^{-3}	3.78×10^{-2}
TRH65FL	4.52×10^{-2}	8.76×10^{-3}	4.52×10^{-2}	8.76×10^{-3}	3.24×10^{-2}
TRH65FE	3.27×10^{-2}	6.77×10^{-3}	3.27×10^{-2}	6.77×10^{-3}	3.24×10^{-2}

K_a : Equivalent moment factor in the pitching direction.

K_b : Equivalent moment factor in the yawing direction.

K_c : Equivalent moment factor in the rolling direction.

ABOUT LINEAR GUIDE

1-6 Safety Factor and Load

Table 1.6.3 TRS-V

Model No.	Equivalent Factors $K_a(\text{mm}^{-1})$		Equivalent Factors $K_b(\text{mm}^{-1})$		Equivalent Factors $K_c(\text{mm}^{-1})$
	Equivalent Load Calculation for a system Using One Linear Guide Block	Equivalent Load Calculation for a system Using Two Linear Guide Blocks laid Over One-Another	Equivalent Load Calculation for a system Using One Linear Guide Block	Equivalent Load Calculation for a system Using Two Linear Guide Blocks laid Over One-Another	
TRS15VS	2.29×10^{-1}	4.39×10^{-2}	2.29×10^{-1}	4.39×10^{-2}	1.34×10^{-1}
TRS15VN	1.48×10^{-1}	3.11×10^{-2}	1.48×10^{-1}	3.11×10^{-2}	1.34×10^{-1}
TRS20VS	2.00×10^{-1}	3.58×10^{-2}	2.00×10^{-1}	3.58×10^{-2}	9.90×10^{-2}
TRS20VN	1.25×10^{-1}	2.60×10^{-2}	1.25×10^{-1}	2.60×10^{-2}	9.90×10^{-2}
TRS25VS	1.60×10^{-1}	3.07×10^{-2}	1.60×10^{-1}	3.07×10^{-2}	8.62×10^{-2}
TRS25VN	1.04×10^{-1}	2.17×10^{-2}	1.04×10^{-1}	2.17×10^{-2}	8.62×10^{-2}
TRS30VS	1.47×10^{-1}	2.57×10^{-2}	1.47×10^{-1}	2.57×10^{-2}	7.15×10^{-2}
TRS30VN	8.65×10^{-2}	1.82×10^{-2}	8.65×10^{-2}	1.82×10^{-2}	7.15×10^{-2}
TRS35VS	1.26×10^{-1}	2.30×10^{-2}	1.26×10^{-1}	2.30×10^{-2}	5.85×10^{-2}
TRS35VN	7.87×10^{-2}	1.61×10^{-2}	7.87×10^{-2}	1.61×10^{-2}	5.85×10^{-2}
TRS35VE	5.25×10^{-2}	1.15×10^{-2}	5.25×10^{-2}	1.15×10^{-2}	5.85×10^{-2}
TRS45VN	6.89×10^{-2}	1.39×10^{-2}	6.89×10^{-2}	1.39×10^{-2}	4.38×10^{-2}

K_a : Equivalent moment factor in the pitching direction.

K_b : Equivalent moment factor in the yawing direction.

K_c : Equivalent moment factor in the rolling direction.

Table 1.6.4 TRS-F

Model No.	Equivalent Factors $K_a(\text{mm}^{-1})$		Equivalent Factors $K_b(\text{mm}^{-1})$		Equivalent Factors $K_c(\text{mm}^{-1})$
	Equivalent Load Calculation for a system Using One Linear Guide Block	Equivalent Load Calculation for a system Using Two Linear Guide Blocks laid Over One-Another	Equivalent Load Calculation for a system Using One Linear Guide Block	Equivalent Load Calculation for a system Using Two Linear Guide Blocks laid Over One-Another	
TRS15FS	2.29×10^{-1}	4.39×10^{-2}	2.29×10^{-1}	4.39×10^{-2}	1.34×10^{-1}
TRS15FN	1.48×10^{-1}	3.11×10^{-2}	1.48×10^{-1}	3.11×10^{-2}	1.34×10^{-1}
TRS20FS	2.00×10^{-1}	3.58×10^{-2}	2.00×10^{-1}	3.58×10^{-2}	9.90×10^{-2}
TRS20FN	1.25×10^{-1}	2.60×10^{-2}	1.25×10^{-1}	2.60×10^{-2}	9.90×10^{-2}
TRS25FN	1.04×10^{-1}	2.17×10^{-2}	1.04×10^{-1}	2.17×10^{-2}	8.62×10^{-2}

K_a : Equivalent moment factor in the pitching direction.

K_b : Equivalent moment factor in the yawing direction.

K_c : Equivalent moment factor in the rolling direction.

Table 1.6.5 TRC-V

Model No.	Equivalent Factors $K_a(\text{mm}^{-1})$		Equivalent Factors $K_b(\text{mm}^{-1})$		Equivalent Factors $K_c(\text{mm}^{-1})$
	Equivalent Load Calculation for a system Using One Linear Guide Block	Equivalent Load Calculation for a system Using Two Linear Guide Blocks laid Over One-Another	Equivalent Load Calculation for a system Using One Linear Guide Block	Equivalent Load Calculation for a system Using Two Linear Guide Blocks laid Over One-Another	
TRC25VE	7.35×10^{-2}	1.60×10^{-2}	7.35×10^{-2}	1.60×10^{-2}	8.62×10^{-2}

K_a : Equivalent moment factor in the pitching direction.

K_b : Equivalent moment factor in the yawing direction.

K_c : Equivalent moment factor in the rolling direction.

ABOUT LINEAR GUIDE

1-6 Safety Factor and Load

Table 1.6.6 TM-N

Model No.	Equivalent Factors $K_a(\text{mm}^{-1})$		Equivalent Factors $K_b(\text{mm}^{-1})$		Equivalent Factors $K_c(\text{mm}^{-1})$
	Equivalent Load Calculation for a system Using One Linear Guide Block	Equivalent Load Calculation for a system Using Two Linear Guide Blocks laid Over One-Another	Equivalent Load Calculation for a system Using One Linear Guide Block	Equivalent Load Calculation for a system Using Two Linear Guide Blocks laid Over One-Another	
TM07NN	8.88×10^{-1}	6.31×10^{-2}	8.88×10^{-1}	6.31×10^{-2}	2.74×10^{-1}
TM07NL	4.41×10^{-1}	5.16×10^{-2}	4.41×10^{-1}	5.16×10^{-2}	2.74×10^{-1}
TM09NN	4.41×10^{-1}	5.26×10^{-2}	4.41×10^{-1}	5.26×10^{-2}	2.19×10^{-1}
TM09NL	2.76×10^{-1}	4.08×10^{-2}	2.76×10^{-1}	4.08×10^{-2}	2.19×10^{-1}
TM12NN	4.90×10^{-1}	4.32×10^{-2}	4.90×10^{-1}	4.32×10^{-2}	1.64×10^{-1}
TM12NL	2.67×10^{-1}	3.42×10^{-2}	2.67×10^{-1}	3.42×10^{-2}	1.64×10^{-1}
TM15NN	3.60×10^{-1}	3.61×10^{-2}	3.60×10^{-1}	3.61×10^{-2}	1.32×10^{-1}
TM15NL	1.94×10^{-1}	2.76×10^{-2}	1.94×10^{-1}	2.76×10^{-2}	1.32×10^{-1}

K_a : Equivalent moment factor in the pitching direction.

K_b : Equivalent moment factor in the yawing direction.

K_c : Equivalent moment factor in the rolling direction.

Table 1.6.7 TM-W

Model No.	Equivalent Factors $K_a(\text{mm}^{-1})$		Equivalent Factors $K_b(\text{mm}^{-1})$		Equivalent Factors $K_c(\text{mm}^{-1})$
	Equivalent Load Calculation for a system Using One Linear Guide Block	Equivalent Load Calculation for a system Using Two Linear Guide Blocks laid Over One-Another	Equivalent Load Calculation for a system Using One Linear Guide Block	Equivalent Load Calculation for a system Using Two Linear Guide Blocks laid Over One-Another	
TM09WN	2.27×10^{-1}	3.01×10^{-2}	2.27×10^{-1}	3.01×10^{-2}	7.92×10^{-2}
TM09WL	1.30×10^{-1}	2.17×10^{-2}	1.30×10^{-1}	2.17×10^{-2}	7.14×10^{-2}
TM12WN	1.85×10^{-1}	2.28×10^{-2}	1.85×10^{-1}	2.28×10^{-2}	5.20×10^{-2}
TM12WL	1.12×10^{-1}	1.72×10^{-2}	1.12×10^{-1}	1.72×10^{-2}	5.05×10^{-2}
TM15WN	1.56×10^{-1}	2.01×10^{-2}	1.56×10^{-1}	2.01×10^{-2}	3.24×10^{-2}
TM15WL	9.07×10^{-2}	1.47×10^{-2}	9.07×10^{-2}	1.47×10^{-2}	3.07×10^{-2}

K_a : Equivalent moment factor in the pitching direction.

K_b : Equivalent moment factor in the yawing direction.

K_c : Equivalent moment factor in the rolling direction.

■ 1-6-2 Calculating the Equivalent Load

The Linear Guide can bear loads and moments from all directions, including a radial load (P_R), reverse-radial load (P_L), and lateral load (P_T), simultaneously.

P_R : Radial load M_A : Moment in the pitching direction
 P_L : Reverse-radial load M_B : Moment in the yawing direction
 P_T : Lateral load M_C : Moment in the rolling direction

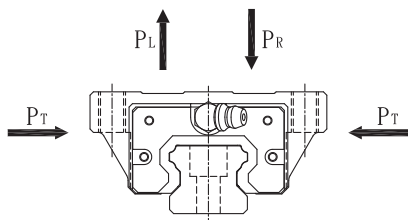

Fig 1.6.3 Directions of the Load and Moment Exerted on the Linear Guide

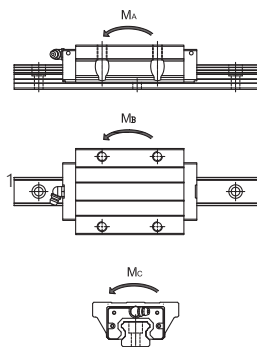

Fig 1.6.4

Equivalent load P_E

When more than one load (e.g., radial and lateral loads) is exerted on the Linear Guide simultaneously, the service life and static safety factors should be calculated by using equivalent load values obtained by converting all loads involved into radial, lateral, and other loads involved.

Equivalent-load equation

The Linear Guide can bear loads and moments from all directions, including a radial load (P_R), reverse-radial load (P_L) and lateral load (P_T) simultaneously.

When a radial load ($P_{R(L)}$) and a lateral (P_T) are applied simultaneously the equivalent load can be obtained by using the following equation.

$$P_E : (\text{equivalent load}) = X \cdot P_{R(L)} + Y \cdot P_T$$

$P_{R(L)}$: Radial load

P_T : Lateral load

$X, Y = 1$

ABOUT LINEAR GUIDE

1-7 Calculation of Average Working Load

1-7-1 Calculating the Mean Load

An industrial robot grasp a workpiece by its arm as it advances, moving forward with the load, when it returns, the arm has no load other than its tare. In a machine tool, Linear Guide blocks receive variable loads according to the host-system operating conditions. Therefore, the calculation of service life should take such fluctuation into consideration.

When the service life of a Linear Guide with variable load is equal to the one with certain load then that certain load is called the Mean Load (P_m).

$$P_m = \sqrt[3]{\frac{1}{L} \cdot \sum (P_n^3 \cdot L_n)}$$

- P_m : Mean load (N)
- P_n : Varying load (N)
- L_c : Total running distance (mm)
- L_n : Running distance under load P_n (mm)

(1) For Loads with Stepwise Change

$$P_m = \sqrt[3]{\frac{1}{L} (P_1^3 \cdot L_1 + P_2^3 \cdot L_2 \dots + P_n^3 \cdot L_n)} \dots \dots \dots (1)$$

- P_m : Mean load (N)
- P_n : Varying load (N)
- L_c : Total running distance (mm)
- L_n : Running distance under load P_n (mm)

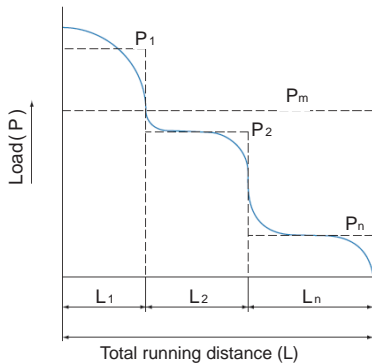

Fig 1.7.1

※ This equation and equation (1) below apply in cases in which the rolling elements are balls.

(2) For Loads with Monotonous Changes

$$P_m \doteq \frac{1}{3} (P_{\min} + 2 \cdot P_{\max}) \dots\dots\dots (2)$$

P_{\min} : minimum load (N)

P_{\max} : maximum load (N)

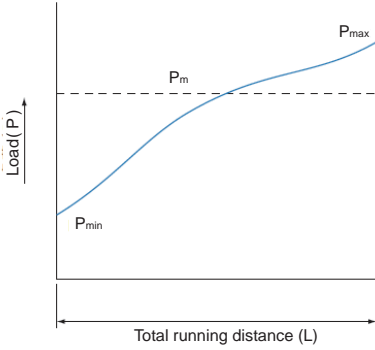

Fig 1.7.2

(3) For Loads with Sinusoidal Changes

$$P_m \doteq 0.65P_{\max} \dots\dots\dots (3)$$

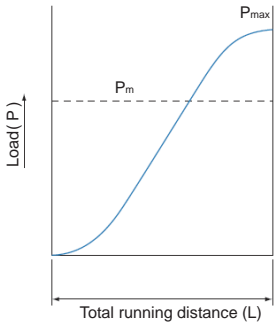

Fig 1.7.3

$$P_m \doteq 0.75P_{\max} \dots\dots\dots (4)$$

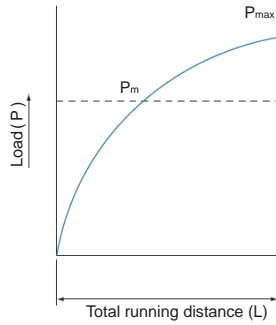

Fig 1.7.4

ABOUT LINEAR GUIDE

1-7 Calculation of Average Working Load

■ 1-7-2 Mean Load Calculation Example (I)

(1) Horizontal Installations are subjected to Acceleration and Deceleration

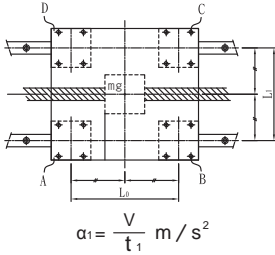

Fig 1.7.5

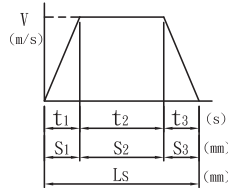

Fig 1.7.6

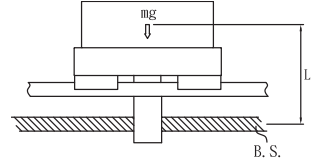

Fig 1.7.7

(2) Load Applied to the Linear Guide Block

1. During uniform motion
2. During acceleration
3. During deceleration

$$P_1 = + \frac{mg}{4}$$

$$P_2 = + \frac{mg}{4}$$

$$P_3 = + \frac{mg}{4}$$

$$P_4 = + \frac{mg}{4}$$

$$P_{a_1} = P_1 + \frac{m \cdot \alpha_1 \cdot L_s}{2 \cdot L_0}$$

$$P_{a_2} = P_2 + \frac{m \cdot \alpha_1 \cdot L_s}{2 \cdot L_0}$$

$$P_{a_3} = P_3 + \frac{m \cdot \alpha_1 \cdot L_s}{2 \cdot L_0}$$

$$P_{a_4} = P_4 + \frac{m \cdot \alpha_1 \cdot L_s}{2 \cdot L_0}$$

$$P_{d_1} = P_1 - \frac{m \cdot \alpha_1 \cdot L_s}{2 \cdot L_0}$$

$$P_{d_2} = P_2 - \frac{m \cdot \alpha_1 \cdot L_s}{2 \cdot L_0}$$

$$P_{d_3} = P_3 - \frac{m \cdot \alpha_1 \cdot L_s}{2 \cdot L_0}$$

$$P_{d_4} = P_4 - \frac{m \cdot \alpha_1 \cdot L_s}{2 \cdot L_0}$$

(3) Mean Load

$$P_{m_1} = \sqrt[3]{\frac{1}{L_s} (P_{a_1}^3 \cdot S_1 + P_1^3 \cdot S_2 + P_{d_1}^3 \cdot S_3)}$$

$$P_{m_2} = \sqrt[3]{\frac{1}{L_s} (P_{a_2}^3 \cdot S_1 + P_2^3 \cdot S_2 + P_{d_2}^3 \cdot S_3)}$$

$$P_{m_3} = \sqrt[3]{\frac{1}{L_s} (P_{a_3}^3 \cdot S_1 + P_3^3 \cdot S_2 + P_{d_3}^3 \cdot S_3)}$$

$$P_{m_4} = \sqrt[3]{\frac{1}{L_s} (P_{a_4}^3 \cdot S_1 + P_4^3 \cdot S_2 + P_{d_4}^3 \cdot S_3)}$$

※ Pan1 · Pdn represent loads exerted on the Linear Guide block. The suffix "n" indicates the block number in the diagram above.

Mean Load Calculation Example (II)

(1) Operating conditions-Installations on Rails.

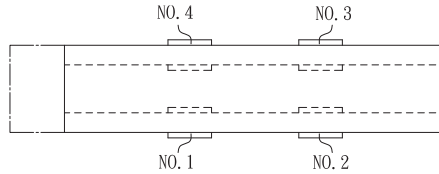

Fig 1.7.8

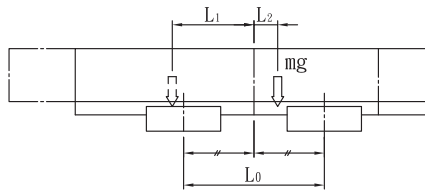

Fig 1.7.9

(2) Load applied to the Linear Guide block

1. At the left of the arm
2. At the right of the arm

(3) Mean load

$$P_{L1} = + \frac{mg}{4} + \frac{mg \cdot L_1}{2 \cdot L_0}$$

$$P_{r1} = + \frac{mg}{4} - \frac{mg \cdot L_1}{2 \cdot L_0}$$

$$P_{m1} = \frac{1}{3} (2 \cdot |P_{L1}| + |P_{r1}|)$$

$$P_{L2} = + \frac{mg}{4} - \frac{mg \cdot L_1}{2 \cdot L_0}$$

$$P_{r2} = + \frac{mg}{4} + \frac{mg \cdot L_1}{2 \cdot L_0}$$

$$P_{m1} = \frac{1}{3} (2 \cdot |P_{L2}| + |P_{r2}|)$$

$$P_{L3} = + \frac{mg}{4} - \frac{mg \cdot L_1}{2 \cdot L_0}$$

$$P_{r3} = + \frac{mg}{4} + \frac{mg \cdot L_1}{2 \cdot L_0}$$

$$P_{m1} = \frac{1}{3} (2 \cdot |P_{L3}| + |P_{r3}|)$$

$$P_{L4} = + \frac{mg}{4} + \frac{mg \cdot L_1}{2 \cdot L_0}$$

$$P_{r4} = + \frac{mg}{4} - \frac{mg \cdot L_1}{2 \cdot L_0}$$

$$P_{m1} = \frac{1}{3} (2 \cdot |P_{L4}| + |P_{r4}|)$$

※ P_{Ln} · P_{rn} represent loads exerted on the Linear Guide block. The suffix "n" indicates the block number in the diagram above.

ABOUT LINEAR GUIDE

1-8 Calculation Example

1-8-1 Calculation Examples (I)

(1) Operating conditions-Horizontal installations subjected to high acceleration and deceleration.

Model number : TRH30FE

Basic dynamic-load rating $C = 4791 \text{ kgf}$

Basic static-load rating $C_0 = 9004 \text{ kgf}$

Gravitational acceleration : $g = 9.8 \text{ (m/s}^2\text{)}$

Load : $m_1 = 600 \text{ kg}$

Load : $m_2 = 380 \text{ kg}$

Velocity : $V = 0.5 \text{ m/s}$

Time : $t_1 = 0.05 \text{ s}$

Time : $t_2 = 2.8 \text{ s}$

Time : $t_3 = 0.15 \text{ s}$

Acceleration : $a_1 = 10 \text{ m/s}^2$

Deceleration : $a_3 = 3.333 \text{ m/s}^2$

Stroke : $L_s = 1450 \text{ mm}$

Distance : $L_0 = 600 \text{ mm}$

$L_1 = 400 \text{ mm}$

$L_2 = 100 \text{ mm}$

$L_3 = 50 \text{ mm}$

$L_4 = 200 \text{ mm}$

$L_5 = 400 \text{ mm}$

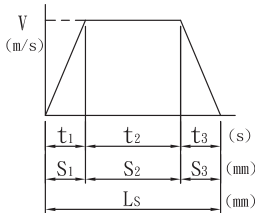

Fig 1.8.1

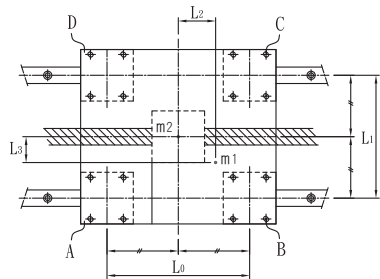

Fig 1.8.2

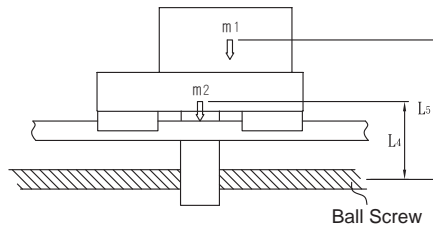

Fig 1.8.3

(2) Load Exerted on the Linear Guide by the Linear Guide Block

The calculations of blocks' load distribution under various circumstances.

1. In uniform motion Load applied in radial direction P_n (Base on the first condition of load exerted (please refer to page A15, No.1), taking m_1 and m_2 into consideration.

$$P_A = \frac{m_1}{4} - \frac{m_1 \cdot L_2}{2 \cdot L_0} + \frac{m_1 \cdot L_3}{2 \cdot L_1} + \frac{m_2}{4} = 232.5 \text{ kg} \quad P_C = \frac{m_1}{4} + \frac{m_1 \cdot L_2}{2 \cdot L_0} - \frac{m_1 \cdot L_3}{2 \cdot L_1} + \frac{m_2}{4} = 257.5 \text{ kg}$$

$$P_B = \frac{m_1}{4} + \frac{m_1 \cdot L_2}{2 \cdot L_0} + \frac{m_1 \cdot L_3}{2 \cdot L_1} + \frac{m_2}{4} = 332.5 \text{ kg} \quad P_D = \frac{m_1}{4} - \frac{m_1 \cdot L_2}{2 \cdot L_0} - \frac{m_1 \cdot L_3}{2 \cdot L_1} + \frac{m_2}{4} = 157.5 \text{ kg}$$

2. During acceleration to the left Load applied in radial direction P_{nL_a} and lateral direction P_{ntL_a} (Base on the 8th condition of load exerted (please refer to page A18, No.8). The load should allocate on the central of table, and $\frac{m_1}{4}$ should be re-placed (please refer to page A15, No.1) by P_n).

$$P_{AL_a} = P_A - \frac{m_1 \cdot a_1 \cdot L_5}{2 \cdot L_0 \cdot g} - \frac{m_2 \cdot a_1 \cdot L_4}{2 \cdot L_0 \cdot g} = -35.93 \text{ kg} \quad P_{CL_a} = P_C - \frac{m_1 \cdot a_1 \cdot L_5}{2 \cdot L_0 \cdot g} - \frac{m_2 \cdot a_1 \cdot L_4}{2 \cdot L_0 \cdot g} = -10.93 \text{ kg}$$

$$P_{BL_a} = P_B - \frac{m_1 \cdot a_1 \cdot L_5}{2 \cdot L_0 \cdot g} - \frac{m_2 \cdot a_1 \cdot L_4}{2 \cdot L_0 \cdot g} = 64.07 \text{ kg} \quad P_{DL_a} = P_D - \frac{m_1 \cdot a_1 \cdot L_5}{2 \cdot L_0 \cdot g} - \frac{m_2 \cdot a_1 \cdot L_4}{2 \cdot L_0 \cdot g} = -110.93 \text{ kg}$$

$$P_{A1L_a} = -\frac{m_1 \cdot a_1 \cdot L_3}{2 \cdot L_0 \cdot g} = -25.48 \text{ kg} \quad P_{C1L_a} = \frac{m_1 \cdot a_1 \cdot L_3}{2 \cdot L_0 \cdot g} = 25.48 \text{ kg}$$

$$P_{B1L_a} = \frac{m_1 \cdot a_1 \cdot L_3}{2 \cdot L_0 \cdot g} = 25.48 \text{ kg} \quad P_{D1L_a} = -\frac{m_1 \cdot a_1 \cdot L_3}{2 \cdot L_0 \cdot g} = -25.48 \text{ kg}$$

3. During deceleration to the left Load applied in radial direction P_{nL_d}

$$P_{AL_d} = P_A + \frac{m_1 \cdot a_3 \cdot L_5}{2 \cdot L_0 \cdot g} + \frac{m_2 \cdot a_3 \cdot L_4}{2 \cdot L_0 \cdot g} = 321.89 \text{ kg} \quad P_{CL_d} = P_C - \frac{m_1 \cdot a_3 \cdot L_5}{2 \cdot L_0 \cdot g} - \frac{m_2 \cdot a_3 \cdot L_4}{2 \cdot L_0 \cdot g} = 168.11 \text{ kg}$$

$$P_{BL_d} = P_B - \frac{m_1 \cdot a_3 \cdot L_5}{2 \cdot L_0 \cdot g} - \frac{m_2 \cdot a_3 \cdot L_4}{2 \cdot L_0 \cdot g} = 243.11 \text{ kg} \quad P_{DL_d} = P_D + \frac{m_1 \cdot a_3 \cdot L_5}{2 \cdot L_0 \cdot g} + \frac{m_2 \cdot a_3 \cdot L_4}{2 \cdot L_0 \cdot g} = 246.89 \text{ kg}$$

Load applied in lateral direction P_{ntL_d}

$$P_{A1L_d} = \frac{m_1 \cdot a_3 \cdot L_3}{2 \cdot L_0 \cdot g} = 8.5 \text{ kg} \quad P_{C1L_d} = -\frac{m_1 \cdot a_3 \cdot L_3}{2 \cdot L_0 \cdot g} = -8.5 \text{ kg}$$

$$P_{B1L_d} = -\frac{m_1 \cdot a_3 \cdot L_3}{2 \cdot L_0 \cdot g} = -8.5 \text{ kg} \quad P_{D1L_d} = \frac{m_1 \cdot a_3 \cdot L_3}{2 \cdot L_0 \cdot g} = 8.5 \text{ kg}$$

ABOUT LINEAR GUIDE

1-8 Calculation Example

4. During acceleration to the right Load applied in radial direction P_{nR_a}

$$P_{A R_a} = P_A + \frac{m_1 \cdot a_1 \cdot L_5}{2 \cdot L_0 \cdot g} + \frac{m_2 \cdot a_1 \cdot L_4}{2 \cdot L_0 \cdot g} = 500.93 \text{ kg} \quad P_{C R_a} = P_C - \frac{m_1 \cdot a_1 \cdot L_5}{2 \cdot L_0 \cdot g} - \frac{m_2 \cdot a_1 \cdot L_4}{2 \cdot L_0 \cdot g} = -10.93 \text{ kg}$$

$$P_{B R_a} = P_B - \frac{m_1 \cdot a_1 \cdot L_5}{2 \cdot L_0 \cdot g} - \frac{m_2 \cdot a_1 \cdot L_4}{2 \cdot L_0 \cdot g} = 64.07 \text{ kg} \quad P_{D R_a} = P_D + \frac{m_1 \cdot a_1 \cdot L_5}{2 \cdot L_0 \cdot g} + \frac{m_2 \cdot a_1 \cdot L_4}{2 \cdot L_0 \cdot g} = 425.93 \text{ kg}$$

Load applied in lateral direction P_{nL_d}

$$P_{A L_d} = \frac{m_1 \cdot a_1 \cdot L_3}{2 \cdot L_0 \cdot g} = 25.48 \text{ kg} \quad P_{C L_d} = -\frac{m_1 \cdot a_1 \cdot L_3}{2 \cdot L_0 \cdot g} = -25.48 \text{ kg}$$

$$P_{B L_d} = -\frac{m_1 \cdot a_1 \cdot L_3}{2 \cdot L_0 \cdot g} = -25.48 \text{ kg} \quad P_{D L_d} = \frac{m_1 \cdot a_1 \cdot L_3}{2 \cdot L_0 \cdot g} = 25.48 \text{ kg}$$

5. During deceleration to the right Load applied in radial direction P_{nR_d} and Load applied in lateral direction P_{nL_d}

$$P_{A R_d} = P_A - \frac{m_1 \cdot a_3 \cdot L_5}{2 \cdot L_0 \cdot g} - \frac{m_2 \cdot a_3 \cdot L_4}{2 \cdot L_0 \cdot g} = 143.11 \text{ kg}$$

$$P_{B R_d} = P_B + \frac{m_1 \cdot a_3 \cdot L_5}{2 \cdot L_0 \cdot g} + \frac{m_2 \cdot a_3 \cdot L_4}{2 \cdot L_0 \cdot g} = 421.89 \text{ kg}$$

$$P_{C R_d} = P_C + \frac{m_1 \cdot a_3 \cdot L_5}{2 \cdot L_0 \cdot g} + \frac{m_2 \cdot a_3 \cdot L_4}{2 \cdot L_0 \cdot g} = 346.89 \text{ kg}$$

$$P_{D R_d} = P_D - \frac{m_1 \cdot a_3 \cdot L_5}{2 \cdot L_0 \cdot g} - \frac{m_2 \cdot a_3 \cdot L_4}{2 \cdot L_0 \cdot g} = 68.11 \text{ kg}$$

Load applied in lateral direction P_{nL_d}

$$P_{A L_d} = -\frac{m_1 \cdot a_3 \cdot L_3}{2 \cdot L_0 \cdot g} = -8.5 \text{ kg} \quad P_{C L_d} = \frac{m_1 \cdot a_3 \cdot L_3}{2 \cdot L_0 \cdot g} = 8.5 \text{ kg}$$

$$P_{B L_d} = \frac{m_1 \cdot a_3 \cdot L_3}{2 \cdot L_0 \cdot g} = 8.5 \text{ kg} \quad P_{D L_d} = -\frac{m_1 \cdot a_3 \cdot L_3}{2 \cdot L_0 \cdot g} = -8.5 \text{ kg}$$

(3) Combined radial and thrust load P_{En}

1. In uniform motion P_{En}

$$P_{EA} = P_A = 232.5 \text{ kg}$$

$$P_{EB} = P_B = 332.5 \text{ kg}$$

$$P_{EC} = P_C = 257.5 \text{ kg}$$

$$P_{ED} = P_D = 157.5 \text{ kg}$$

2. During acceleration to the left P_{EnL_a}

$$P_{EAL_a} = |P_{AL_a}| + |P_{AtL_a}| = 61.41 \text{ kg}$$

$$P_{EBL_a} = |P_{BL_a}| + |P_{BtL_a}| = 89.55 \text{ kg}$$

$$P_{ECL_a} = |P_{CL_a}| + |P_{CtL_a}| = 36.41 \text{ kg}$$

$$P_{EDL_a} = |P_{DL_a}| + |P_{DtL_a}| = 136.41 \text{ kg}$$

3. During deceleration to the left P_{EnL_d}

$$P_{EAL_d} = |P_{AL_d}| + |P_{AtL_d}| = 330.39 \text{ kg}$$

$$P_{EBL_d} = |P_{BL_d}| + |P_{BtL_d}| = 251.61 \text{ kg}$$

$$P_{ECL_d} = |P_{CL_d}| + |P_{CtL_d}| = 176.61 \text{ kg}$$

$$P_{EDL_d} = |P_{DL_d}| + |P_{DtL_d}| = 255.39 \text{ kg}$$

4. During acceleration to the right P_{EnR_a}

$$P_{EAR_a} = |P_{AR_a}| + |P_{AtR_a}| = 509.43 \text{ kg}$$

$$P_{EBR_a} = |P_{BR_a}| + |P_{BtR_a}| = 72.57 \text{ kg}$$

$$P_{ECR_a} = |P_{CR_a}| + |P_{CtR_a}| = 19.43 \text{ kg}$$

$$P_{EDR_a} = |P_{DR_a}| + |P_{DtR_a}| = 434.43 \text{ kg}$$

5. During deceleration to the right P_{EnR_d}

$$P_{EAR_d} = |P_{AR_d}| + |P_{AtR_d}| = 151.61 \text{ kg}$$

$$P_{EBR_d} = |P_{BR_d}| + |P_{BtR_d}| = 430.39 \text{ kg}$$

$$P_{ECR_d} = |P_{CR_d}| + |P_{CtR_d}| = 355.39 \text{ kg}$$

$$P_{EDR_d} = |P_{DR_d}| + |P_{DtR_d}| = 76.61 \text{ kg}$$

(4) Static Safety Factor

As shown above, it is during acceleration of the B Linear Guide to the left when the maximum load is exerted on the Linear Guide. Therefore, the static safety factor (f_s) becomes as follows :

$$f_s = \frac{C_0}{509.43} = \frac{9004}{509.43} = 17.67$$

ABOUT LINEAR GUIDE

1-8 Calculation Example

(5) Mean Load P_{mn}

For each block, load is different under uniform speed, acceleration and deceleration circumstances. To acquire service life, mean load must be calculated by acquiring the travel distance of each block during uniform speed, acceleration and deceleration in advance.

$$S_1 = \frac{1}{2} t_1 V = \frac{1}{2} (0.05)(0.5)m = 0.0125m = 12.5 \text{ mm} \quad S_3 = \frac{1}{2} t_3 V = (0.15)(0.5)m = 0.0375m = 37.5 \text{ mm}$$

$$S_2 = t_2 V = (2.8)(0.5)m = 1.4m = 1400 \text{ mm} \quad \text{Nominal Life } L_S = S_1 + S_2 + S_3 = 1450 \text{ mm}$$

The mean load on each LM block is as follows :

$$P_{MA} = \sqrt[3]{\frac{1}{2 \cdot L_S} (P_{EA}^3 \cdot a \cdot S_1 + P_{EA}^3 \cdot S_2 + P_{EA}^3 \cdot d \cdot S_3 + P_{EA}^3 \cdot R_a \cdot S_1 + P_{EA}^3 \cdot S_2 + P_{EA}^3 \cdot R_d \cdot S_3)} = 236.43 \text{ kg}$$

$$P_{MB} = \sqrt[3]{\frac{1}{2 \cdot L_S} (P_{EB}^3 \cdot a \cdot S_1 + P_{EB}^3 \cdot S_2 + P_{EB}^3 \cdot d \cdot S_3 + P_{EB}^3 \cdot R_a \cdot S_1 + P_{EB}^3 \cdot S_2 + P_{EB}^3 \cdot R_d \cdot S_3)} = 332.42 \text{ kg}$$

$$P_{MC} = \sqrt[3]{\frac{1}{2 \cdot L_S} (P_{EC}^3 \cdot a \cdot S_1 + P_{EC}^3 \cdot S_2 + P_{EC}^3 \cdot d \cdot S_3 + P_{EC}^3 \cdot R_a \cdot S_1 + P_{EC}^3 \cdot S_2 + P_{EC}^3 \cdot R_d \cdot S_3)} = 257.82 \text{ kg}$$

$$P_{MD} = \sqrt[3]{\frac{1}{2 \cdot L_S} (P_{ED}^3 \cdot a \cdot S_1 + P_{ED}^3 \cdot S_2 + P_{ED}^3 \cdot d \cdot S_3 + P_{ED}^3 \cdot R_a \cdot S_1 + P_{ED}^3 \cdot S_2 + P_{ED}^3 \cdot R_d \cdot S_3)} = 163.33 \text{ kg}$$

(6) Nominal life L_n (Assume $f_w = 1.5$)

$$(L_A = \frac{C}{f_w \cdot P_{MA}})^3 \cdot 50 = 123265.9 \text{ km} \quad (L_C = \frac{C}{f_w \cdot P_{MC}})^3 \cdot 50 = 95069.19 \text{ km}$$

$$(L_B = \frac{C}{f_w \cdot P_{MB}})^3 \cdot 50 = 44351.32 \text{ km} \quad (L_D = \frac{C}{f_w \cdot P_{MD}})^3 \cdot 50 = 373897.7 \text{ km}$$

※ From these calculations, 44351.32 km (the running distance of Linear Guide No.8) is obtained as the service life of the Linear Guide used in a machine or system under the operating conditions specified above.

In the example above, we assume that we have two loads (W_1 and W_2). If there is only one load W_1 , simply take W_2 as zero. The appropriate formula determined by condition of loading.

Example (II)

(1) Operation Conditions-Vertical Installations Table (L type) has combined blocks weight w_1 and w_2 . Furthermore, the mass w_0 is applied during uniform ascent by Distance 1000mm. After the mass is dropped, empty table is removed during uniform descent. The table has total four Linear Guide blocks.

Model number : TRH30FE

(dynamic-load rating : $C = 4791$ kgf)

(static-load rating : $C_0 = 9004$ kgf)

Gravitational Acceleration : $g = 9.8$ (m/s^2)

Mass : $m_0 = 200$ kg

Weight of Table1 : $m_1 = 400$ kg

Weight of Table2 : $m_2 = 200$ kg

$L_0 = 300$ mm

$L_1 = 80$ mm

$L_2 = 50$ mm

$L_3 = 280$ mm

$L_4 = 150$ mm

$L_5 = 250$ mm

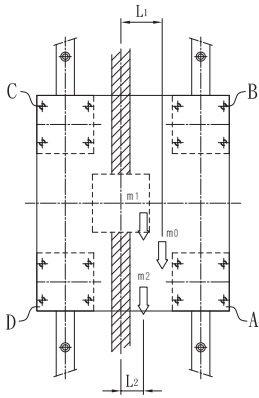

The mass is applied during ascent only.
It is removed during descent.

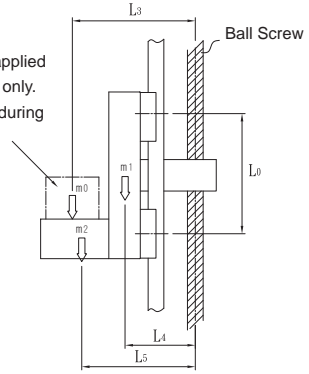

Fig 1.8.4

ABOUT LINEAR GUIDE

1-8 Calculation Example

(2) Calculation of blocks load distribution under various circumstances.

When the Linear Guide move vertically, take M_0 , M_1 and M_2 into consideration individually by using the third condition shown in 1.5.1 【please refer to A16. No.3】

1. The radial load(P_m) of blocks while ascending with load M_0 .

$$P_{AU} = \frac{m_1 \cdot L_4}{2 \cdot L_0} + \frac{m_2 \cdot L_5}{2 \cdot L_0} + \frac{m_0 \cdot L_3}{2 \cdot L_0} = 276.7 \text{ kg} \quad P_{CU} = -\frac{m_1 \cdot L_4}{2 \cdot L_0} - \frac{m_2 \cdot L_5}{2 \cdot L_0} - \frac{m_0 \cdot L_3}{2 \cdot L_0} = -276.7 \text{ kg}$$

$$P_{BU} = -\frac{m_1 \cdot L_4}{2 \cdot L_0} - \frac{m_2 \cdot L_5}{2 \cdot L_0} - \frac{m_0 \cdot L_3}{2 \cdot L_0} = -276.7 \text{ kg} \quad P_{DU} = \frac{m_1 \cdot L_4}{2 \cdot L_0} + \frac{m_2 \cdot L_5}{2 \cdot L_0} + \frac{m_0 \cdot L_3}{2 \cdot L_0} = 276.7 \text{ kg}$$

Lateral load $P_n T_u$ of blocks while ascending.

$$P_{ATU} = \frac{m_1 \cdot L_2}{2 \cdot L_0} + \frac{m_2 \cdot L_2}{2 \cdot L_0} + \frac{m_0 \cdot L_1}{2 \cdot L_0} = 76.7 \text{ kg} \quad P_{CTU} = -\frac{m_1 \cdot L_2}{2 \cdot L_0} - \frac{m_2 \cdot L_2}{2 \cdot L_0} - \frac{m_0 \cdot L_1}{2 \cdot L_0} = -76.7 \text{ kg}$$

$$P_{BTU} = -\frac{m_1 \cdot L_2}{2 \cdot L_0} - \frac{m_2 \cdot L_2}{2 \cdot L_0} - \frac{m_0 \cdot L_1}{2 \cdot L_0} = -76.7 \text{ kg} \quad P_{DTU} = \frac{m_1 \cdot L_2}{2 \cdot L_0} + \frac{m_2 \cdot L_2}{2 \cdot L_0} + \frac{m_0 \cdot L_1}{2 \cdot L_0} = 76.7 \text{ kg}$$

2. Radial load of each block while descending with no load.

$$P_{AD} = \frac{m_1 \cdot L_4}{2 \cdot L_0} + \frac{m_2 \cdot L_5}{2 \cdot L_0} = 183.3 \text{ kg} \quad P_{CD} = -\frac{m_1 \cdot L_4}{2 \cdot L_0} - \frac{m_2 \cdot L_5}{2 \cdot L_0} = -183.3 \text{ kg}$$

$$P_{BD} = -\frac{m_1 \cdot L_4}{2 \cdot L_0} - \frac{m_2 \cdot L_5}{2 \cdot L_0} = -183.3 \text{ kg} \quad P_{DD} = \frac{m_1 \cdot L_4}{2 \cdot L_0} + \frac{m_2 \cdot L_5}{2 \cdot L_0} = 183.3 \text{ kg}$$

Lateral load of block while descending.

$$P_{ATD} = \frac{m_2 \cdot L_2}{2 \cdot L_0} + \frac{m_0 \cdot L_2}{2 \cdot L_0} = 33.3 \text{ kg} \quad P_{CTD} = -\frac{m_2 \cdot L_2}{2 \cdot L_0} - \frac{m_0 \cdot L_2}{2 \cdot L_0} = -33.3 \text{ kg}$$

$$P_{BDT} = -\frac{m_2 \cdot L_2}{2 \cdot L_0} - \frac{m_0 \cdot L_2}{2 \cdot L_0} = -33.3 \text{ kg} \quad P_{DDT} = \frac{m_2 \cdot L_2}{2 \cdot L_0} + \frac{m_0 \cdot L_2}{2 \cdot L_0} = 33.3 \text{ kg}$$

(3) Combined radial and thrust load P_{En}

1. During ascent

$$P_{EAU} = |P_{AU}| + |P_{ATU}| = 353.4 \text{ kg}$$

$$P_{EBU} = |P_{BU}| + |P_{BTU}| = 353.4 \text{ kg}$$

$$P_{ECU} = |P_{CU}| + |P_{CTU}| = 353.4 \text{ kg}$$

$$P_{EDU} = |P_{DU}| + |P_{DTU}| = 353.4 \text{ kg}$$

$$P_{EAD} = |P_{AD}| + |P_{ATD}| = 216.6 \text{ kg}$$

$$P_{EBD} = |P_{BD}| + |P_{BTD}| = 216.6 \text{ kg}$$

$$P_{ECD} = |P_{CD}| + |P_{CTD}| = 216.6 \text{ kg}$$

$$P_{EDD} = |P_{DD}| + |P_{DTD}| = 216.6 \text{ kg}$$

(4) Static Safety Factor

The static safety factor (f_s) of a machine or system under the operating conditions shown above becomes the following :

$$f_s = \frac{C_0}{353.4\text{kg}} = \frac{9004}{353.4} = 25.48$$

(5) Mean Load P_{mn}

$$P_{mA} = \sqrt[3]{\frac{1}{2 \ell_S} (P_{EAU}^3 \cdot \ell_S + P_{EAD}^3 \cdot \ell_S)} = 300.6 \text{ kg} \quad P_{mC} = \sqrt[3]{\frac{1}{2 \ell_S} (P_{ECU}^3 \cdot \ell_S + P_{ECD}^3 \cdot \ell_S)} = 300.6 \text{ kg}$$

$$P_{mB} = \sqrt[3]{\frac{1}{2 \ell_S} (P_{EBU}^3 \cdot \ell_S + P_{EBD}^3 \cdot \ell_S)} = 300.6 \text{ kg} \quad P_{mD} = \sqrt[3]{\frac{1}{2 \ell_S} (P_{EDU}^3 \cdot \ell_S + P_{EDD}^3 \cdot \ell_S)} = 300.6 \text{ kg}$$

(6) Nominal life L_n (Assume $f_w = 1.2$)

$$L_A = \left(\frac{C}{f_w \cdot P_{mA}} \right)^3 \cdot 50\text{km} = 117148.8 \text{ km}$$

$$L_C = \left(\frac{C}{f_w \cdot P_{mC}} \right)^3 \cdot 50\text{km} = 117148.8 \text{ km}$$

$$L_B = \left(\frac{C}{f_w \cdot P_{mB}} \right)^3 \cdot 50 \text{ km} = 117148.8 \text{ km}$$

$$L_D = \left(\frac{C}{f_w \cdot P_{mD}} \right)^3 \cdot 50\text{km} = 117148.8 \text{ km}$$

ABOUT LINEAR GUIDE

1-9 Accuracy

■ 1-9-1 Accuracy Standards

The accuracy of rail is determined by the tolerance of its parallelism, height and width, if there is multiple blocks on a rail or multiple Linear Guide on a surface, the difference of height and width between each block and Linear Guide are standardized and shown in the catalogue.

Running Parallelism

Mount a Linear Guide on a datum surface and measure the parallelism difference of block while operating its full travel distance.

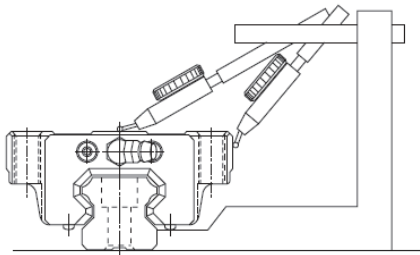

Fig 1.9.1 Running Parallelism

Difference in Height M among Linear Guide Blocks

On the same datum surface, the difference between maximum and minimum height of each block.

Difference in Rail-to-Block Lateral Distance W_2 among Linear Guide Blocks

On the same rail, the difference between maximum and minimum width of each block.

※ Note.1

With two or more sets of Linear Guide installed in parallel on the same plane, the tolerance for the rail-to-block lateral distance (W_2) and the differences therein among Linear Guide blocks apply to the master – rail side only.

※ Note.2

Accuracy measurements indicate mean values of measurements taken at the center or central area of each Linear Guide block.

※ Note.3

Linear Guide rails are smoothly curved so that when they are installed on a machine they are easily straightened, and pressing them onto the machine reference base enables the design accuracy to be achieved. If installed on a base lacking rigidity, such as an aluminum base, the bend of LinearGuide rails may affect machine precision. In such a case, the straightness should be set in advance.

1-9-2 Averaging Effect

The Linear Guide incorporates precision balls with high circularity, enabling a constrained structure with no clearance. Moreover, in a multiple-axis configuration with the axis arranged in parallel to one another, the component Linear Guides therein combine to form an entire constrained guideway.

The effect of equalization is different, due to the error of length, size, preload of rail, axis constrained structure and etc, as the table shown below; adding one rail a straightness error and its actual operating accuracy is shown in the diagram below. Through the feature of equalization, a high operating accuracy structure can be provided.

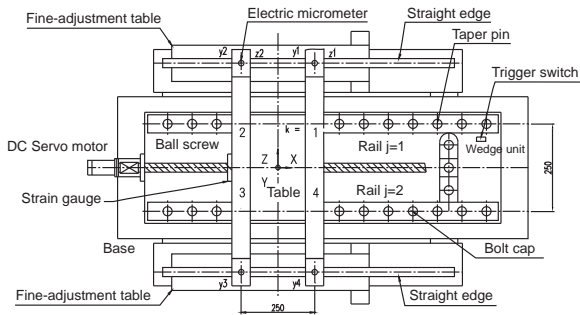

Fig 1.9.2

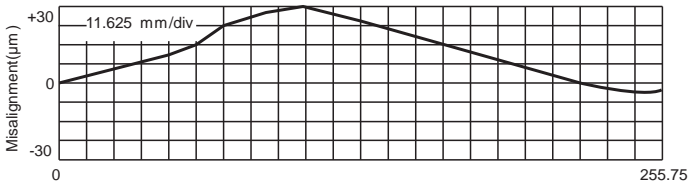

Fig 1.9.3 Misalignment profile

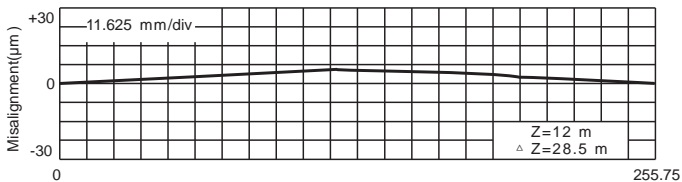

Fig 1.9.4 Horizontal displacement of the table

ABOUT LINEAR GUIDE

1-10 Predicting the Rigidity

■ 1-10-1 Determining Radial Clearance and the Magnitude of a Preload Radial Clearance

The radial clearance of the Linear Guide is the displacement of Linear Guide block caused by the vertical plane when the block is lightly pushed forward or backward at the longitudinal center of the Linear Guide rail secured in place.

The radial clearance is divided into ZF (Slight Clearance), Z0 (No Preload), Clearance Z1 (light preload), Z2 (medium preload) and Z3 (heavy preload). The most appropriate clearance can be selected in accordance with the intended applications. The radial clearances and preload values are standardized for each type of Linear Guide.

The radial clearance of the Linear Guide significantly affects its running precision, load-withstanding performance, and rigidity. It is therefore particularly important to select the correct clearance for your purpose. In general, a negative clearance has a favorable effect on service life and precision, if the Linear Guide is subjected to significant vibration and impact due to reciprocal motion.

Preload

The preload is an internal load exerted on rolling elements in the Linear Guide block, for the purpose of increasing the block rigidity and reducing clearance. Clearance symbol for the Linear Guide, ZF, Z0, Z1, Z2 and Z3 represent negative clearance resulting from a preload and are expressed in negative values. All Linear Guide models (excluding the separate type) are shipped with their clearance adjusted to user specifications. Therefore, it is not necessary for users to adjust the preload themselves. We will select the clearance suited to your operating conditions. Please contact us.

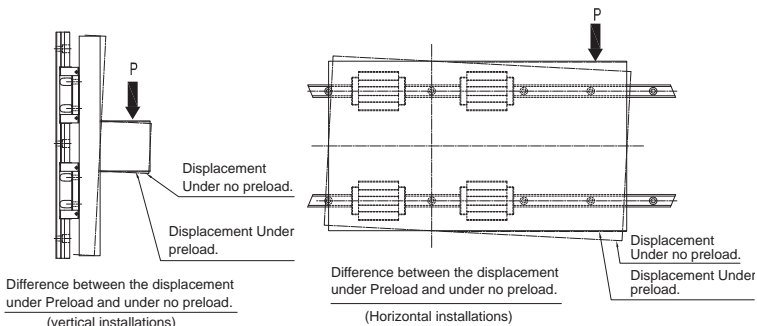

Fig 1.10.1 Relationship Between Preload and Displacement

Table 1.10.1

	Preload		
	ZF~Z0 Slight Clearance, Zero Preload.	Z1 Zero Clearance, Light Preload.	Z2 Zero Clearance, Medium preload.
OperatingConditions	The loading direction is fixed; impact and vibration are slight; two axes are installed in parallel. High precision is not required and the sliding resistance must be low.	The location is under an overhang and a moment load. The Linear Guide is used in a one-axis configuration. The location with light load and high precision requirement.	The location requires light rigidity and is subjected to vibration and impact. The application is a heavy-cutting machine tool or the like.
SampleApplications	<ul style="list-style-type: none"> ◆ Beam-welding machine. ◆ Book-binding machine. ◆ Automatic packing machine. ◆ General-industrial-machine ◆ X-axis and Y-axis. ◆ Automatic sash-bar finishing machine. ◆ Welding machine. ◆ Circuit breaker. ◆ Tool changer. ◆ Various kinds of maternal feeder. 	<ul style="list-style-type: none"> ◆ Grinding-machine table feed shaft. ◆ Automatic painting machine. ◆ Industrial robot. ◆ Various kinds of high-speed material feeder. ◆ NC drilling machine. ◆ General-industrial-machine ◆ Z-axis. ◆ Printed-circuit-board drilling machine. ◆ Electric discharge machine. ◆ Measuring instrument. ◆ Precision XY table. 	<ul style="list-style-type: none"> ◆ Machining center. ◆ NC lathe. ◆ Grinding-machine grinding-wheel feed shaft. ◆ Milling machine. ◆ Vertical-and horizontal-boring machines. ◆ Tool rest guide. ◆ Machine-tool Z-axis.

Applied Load and Service Life Considering

When the Linear Guide is used under a preload (medium), the Linear Guide block receives an internal load. Therefore, the service life should be calculated in consideration of the preload. For preload considerations, please contact us, specifying the model numbers you have selected.

■ 1-10-2 Rigidity

When the Linear Guide receives a load, the steel balls, Linear Guide blocks, and rails undergo elastic deformation within a permissible range. The ratio of deformation to the load is the rigidity value. The rigidity of the Linear Guide increases as the preload increases. The Fig below shows the differences among the ordinary clearance Z1 and clearance Z2, Z3. As shown, in the case of the four-way equal-load type, the effect of preloading remains valid until the load increases to some 2.8 times the preload applied.

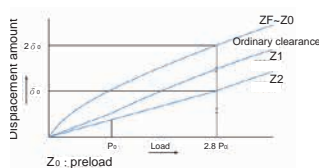

Fig 1.10.2 Rigidity Data

$$\delta = \frac{P}{K} \mu\text{m}$$

- δ : Displacement
- P : Load
- K : Rigidity Value

ABOUT LINEAR GUIDE

1-11 Installation of Linear Guide

■ 1-11-1 Datum Representation

Jointed rail should be installed by following the arrow sign and ordinal number which is marked on the surface of each rail (see Fig 1.11.1) :

Marks

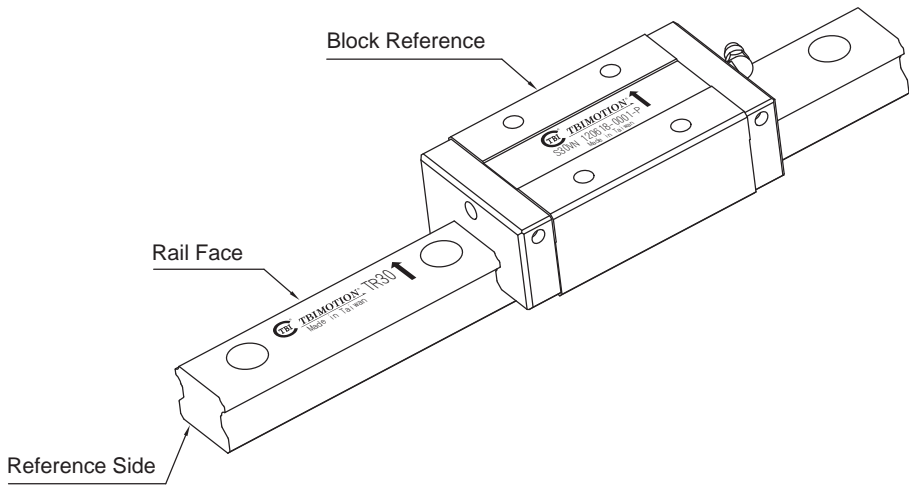
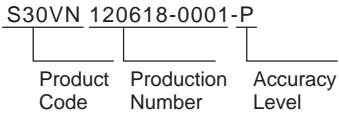

Fig 1.11.1 Datum Representation

■ 1-11-2 Recognizing of Master Rail

Linear rails to be applied on the same plane are all marked with the same serial number, and "M" is marked at the end of serial number for indicating the master rail, shown as the figure below. The reference side of carriage is the surface where is ground to a specified accuracy. For normal grade (N), it has no mark "M" on rail which means any one of rails with same serial number could be the master rail.

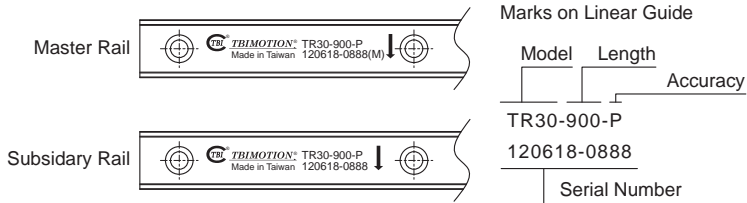

Fig 1.11.2 Recognizing of Master Rail

Combined Use of Rail and Carriage

For combined use, the rail and carriage must have the same serial number. When reinstalling the carriage back to the rail, make sure they have the same serial number and the reference side of carriage should be in accordance with that of rail.

ABOUT LINEAR GUIDE

1-11 Installation of Linear Guide

■ 1-11-3 For Butt-joint Rail

Accuracy may deviate at joints when carriages pass the joint simultaneously. Therefore, the joints should be interlaced for avoiding such accuracy problem.

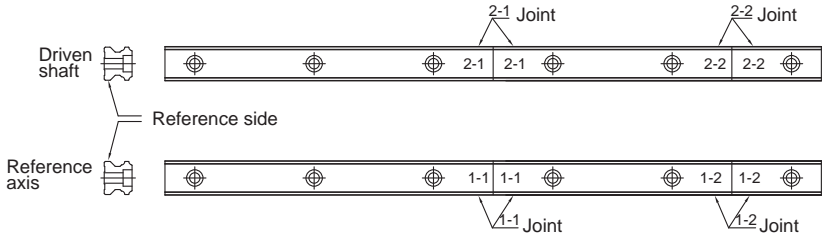

Fig 1.11.3 Butt-joint

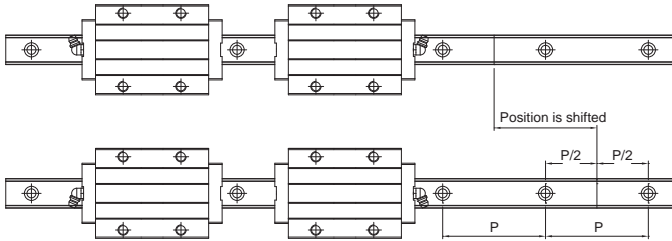
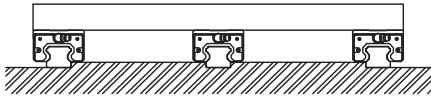
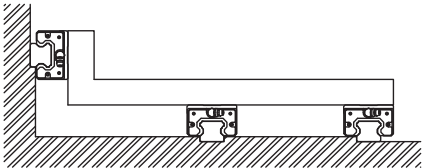
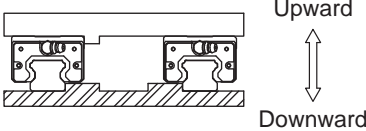
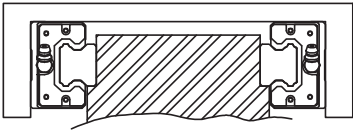
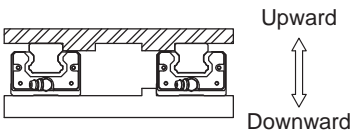
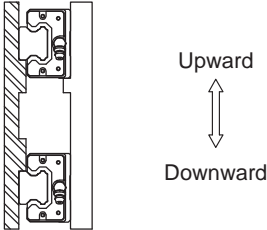
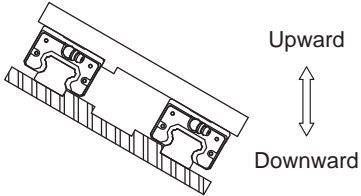
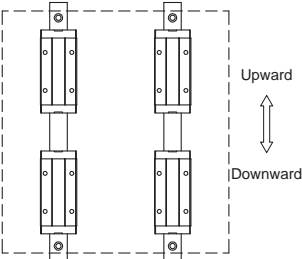

Fig 1.11.4

■ 1-11-4 Mounting Methods

Linear rail is designed to absorb the load of four dimensions; therefore, it can be mounted according to the load and structure of the equipment.

Table 1.11.1

(A) Three-Axis Configuration.	(B) Three-Axis Configuration.
	
Horizontal Configuration.	Two-Axis External Configuration.
	
Upside down Configuration.	Vertical Configuration.
	
Tilted Configuration.	Install on the wall.
	

ABOUT LINEAR GUIDE

1-11 Installation of Linear Guide

■ 1-11-5 Common Fastening Method of Linear Guide

Table 1.11.2

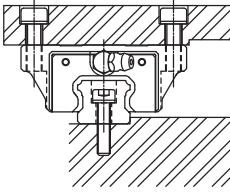
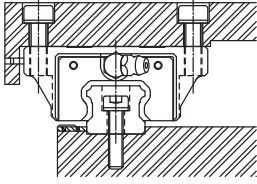
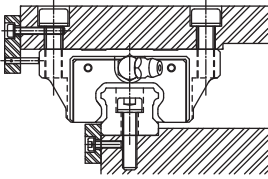
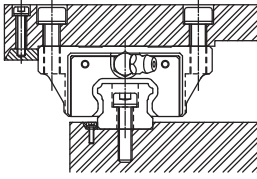
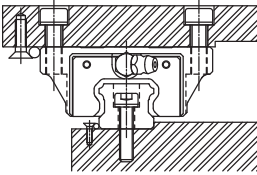
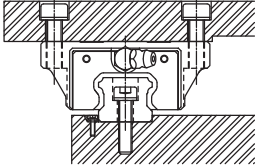
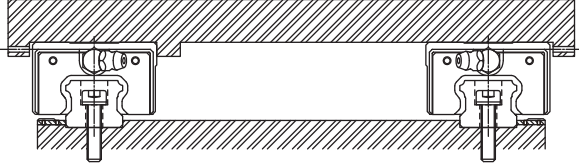
<p>Fastened by pressing both Linear Guide blocks and rail against their respective reference surfaces.</p> 	<p>Fastened by using push screws.</p> 
<p>Fastened by using a hold-down plate.</p> 	<p>Fastened by using a tapered gib.1</p> 
<p>Fastened by using screws.</p> 	<p>Fastened by using a tapered gib.2</p> 
<p>A Setting Where the Host Machine is Subjected to Impact and Vibration.</p>	
	

■ 1-11-6 Mounting the Linear Guide

Mounting Procedures

※ Sample Installation of the Linear Guide on a Vibration-and-Impact Susceptible Machine that Requires Rigidity and High Precision.

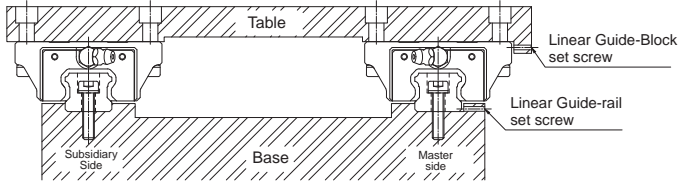

Fig 1.11.5 Mounting the Linear Guide on a Machine Susceptible to Vibration and Impact

Mounting the Linear Guide Rail

(A) Prior to assembly, always remove all burrs, dents and dust that are likely to form on the mounting surface of the machine on which Linear Guide is to be installed. (Fig 1.11.6)

CAUTION : The Linear Guide is delivered with an anticorrosive oil applied. Prior to assembly, be sure to remove the oil from the reference surface using a wash oil. If the anticorrosive oil is removed, the surface is likely to rust. The application of a low-viscosity spindle oil or the like is therefore recommended.

(B) Gently place a Linear Guide rail on the base, and temporarily tighten the bolts so that the rail lightly contacts the mounting surface. Hold the line marked side of the Linear Guide rail against matching the base-side reference surface (Fig 1.11.7)

CAUTION : Use clean bolts to fasten the Linear Guide. When inserting bolts into the Linear Guide rail mounting holes, make sure the threads of the bolt and nut are properly aligned. (Fig 1.11.8)

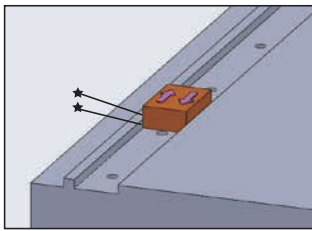

Fig 1.11.6 Checking the Mounting Surface.

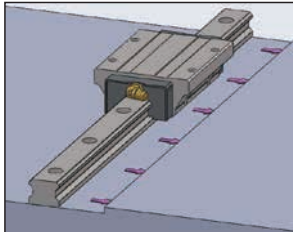

Fig 1.11.7 Holding an Linear Guide rail against the Reference Surface

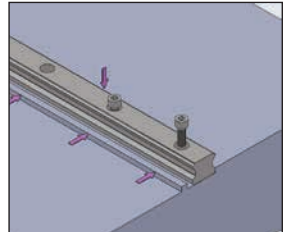

Fig 1.11.8 Checking Bolt Play

ABOUT LINEAR GUIDE

1-11 Installation of Linear Guide

Table 1.11.3 Tightening Torque for Allen Bolt

Unit : N-cm

ModelNo.	Tightening Torque		
	Iron	Casting	Aluminum
M2	57	39.2	29.4
M2.3	78.4	53.9	39.2
M2.6	118	78.4	58.8
M3	186	127	98.0
M4	392	274	206
M5	882	588	441
M6	1370	921	686
M8	3040	2010	1470
M10	6760	4510	3330
M12	11800	7840	5880
M14	15700	10500	7840
M16	19600	13100	9800
M20	38200	25500	19100
M22	51900	34800	26000
M24	65700	44100	32800
M30	130000	87200	65200

(C) Tighten the Linear Guide rail set screws in sequence, until they lightly contact the rail-mounting side surface.(Fig 1.11.9)

(D) Using a torque wrench, tightening the mounting bolts to the specific torque.(fig 1.11.10)

CAUTION : The sequence for tightening the Linear Guide rail mounting bolts should start from the center to the end. Following this sequence to maintain accuracy.

(E) Following the same procedures for the remaining Linear Guide rails, complete Linear Guide rail installation.

(F) Drive caps into the bolt holes on the Linear Guide rails so that they are flush with the rail top surface.

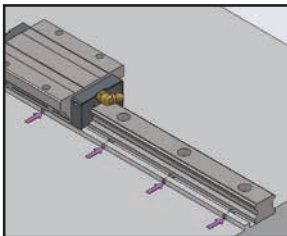

Fig 1.11.9 Tightening Set Screws

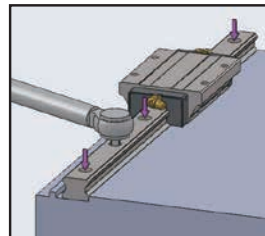

Fig 1.11.10 Full Tightening of Mounting Bolts

Mounting the Linear Guide Block

(A) Gently place a table on the Linear Guide blocks and temporarily tighten the mounting bolts.

(B) Using set screws, hold the master-rail Linear Guide block against the table reference-side surface, and position the table.

(C) Fully tighten the mounting bolts on both the master and subsidiary sides. This completes Linear Guide block installation.

CAUTION : To ensure uniform fastening of the table, tighten the mounting bolts diagonally, as shown in (Fig 1.11.11) in accordance with the numbers.

(D) Using a torque wrench, tightening the mounting bolts to the specified torque.(fig 1.11.10)

CAUTION : The sequence for tightening the Linear Guide rail mounting bolts should start from the center to the end. Following this sequence to maintain.

The method specified above minimizes the time required to ensure the straightness of the Linear Guide-rail. Moreover, there is no need to use the fastening knock pins, thereby greatly reducing the required assembly man-hours.

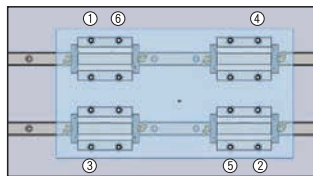

Fig 1.11.11

※ Sample Installation of the Linear Guide without Set Screws on the Master Linear Guide Rail.

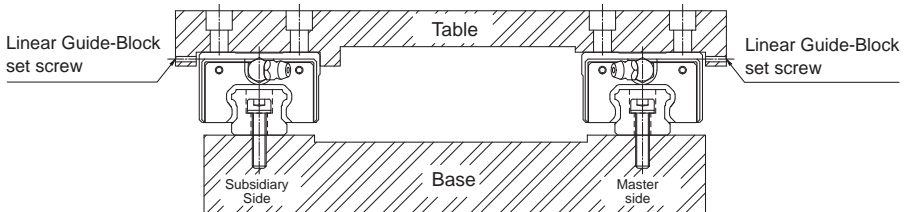

Fig 1.11.12 Mounting the Linear Guide without Set Screws on the Master Linear Guide Rail

ABOUT LINEAR GUIDE

1-11 Installation of Linear Guide

Mounting the Master Linear Guide Rail

After temporarily tightening the mounting bolts, use a small device or the like to firmly press the rail to the side, against the reference section. Fully tighten the mounting bolts. Repeat this for each mounting bolt in sequence. (Fig 1.11.13)

Mounting the Subsidiary Linear Guide Rail

To ensure parallelism of the subsidiary Linear Guide rail with the master Linear Guide rail properly mounted, the following methods are recommended.

Use a Straight Edge

Position a straight edge between the two rails then confirm parallelism with a dial gauge. Using the straight edge as a reference to confirm subsidiary rail straightness from one end to the other, tightening the mounting bolts in sequence as you go. (Fig 1.11.14)

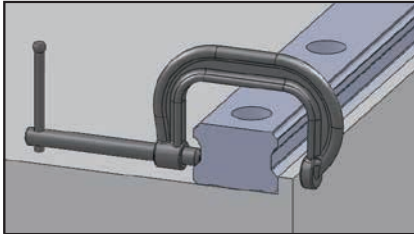

Fig 1.11.13 Mounting the master Linear Guide rail

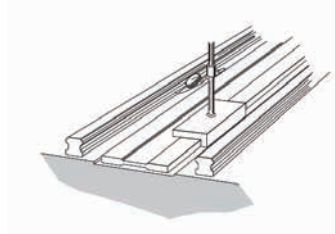

Fig 1.11.14 Use a straight edge

Move the Table

Fasten two Linear Guide blocks on the master side to the table (or a temporary measurement table). Temporarily fasten the subsidiary Linear Guide rail and block to the base and table. From the dial-gauge stand, with a dial gauge contact the subsidiary rail Linear Guide block side, move the table from the rail end and check the parallelism between the block and the subsidiary Linear Guide rail, fastening the bolts on sequences as you go. (Fig 1.11.15)

Compare to the Master Linear Guide Rail

Make sure the master Linear Guide rail is properly installed. Temporarily fasten the subsidiary Linear Guide rail in place. Place a table on the Linear Guide blocks mounted on the master rail and on the temporarily fastened subsidiary Linear Guide rail. Fully tighten the mounting bolts on the two Linear Guide blocks on the subsidiary rail. With the remaining Linear Guide block on the subsidiary rail temporarily fastened, correct the position of the subsidiary Linear Guide rail, fully tightening its mounting bolts in sequence as you go. (Fig 1.11.16)

Method Using a Jig

Using a jig as shown in (Fig 1.11.17) confirm parallelism between the master-rail-side reference surface and that of the subsidiary rail at each mounting hole, and fully tighten the mounting bolt there.

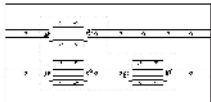

Fig 1.11.15 Move the table

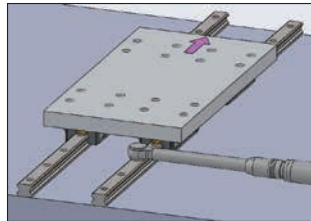

Fig 1.11.16 Compare to the master Linear Guide rail

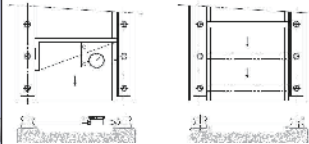

Fig 1.11.17

※ Sample Installation of the Linear Guide without a Reference Section for the Master Linear Guide Rail.

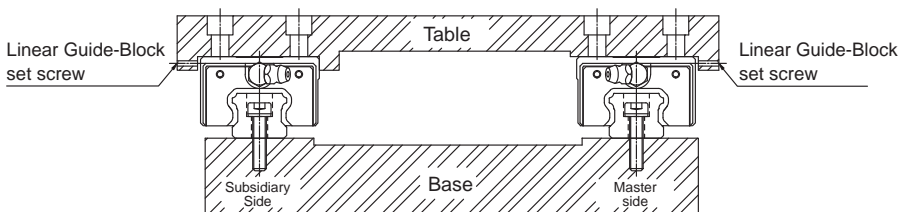

Fig 1.11.18 Installation of the Linear Guide without a Reference Section for the Master Linear Guide Rail

ABOUT LINEAR GUIDE

1-11 Installation of Linear Guide

Mounting the Master Linear Guide Rail

Use a Temporary Reference Surface from end to end to acquire Linear Guide rail straightness. For this method, however, two Linear Guide block must be fastened together, positioned on the top of each other while attached to a measurement plate, as shown in (Fig1.11.19).

Use a Straight Edge

After temporarily tightening the mounting bolts, use a dial gauge to check the straightness of the Linear Guide-rail-side reference surface from end to end, fully tightening the mounting bolts in sequence as you go, as shown in (Fig 1.11.20).

To mount the subsidiary Linear Guide rail, follow the procedures specified in the second paragraph on the previous page.

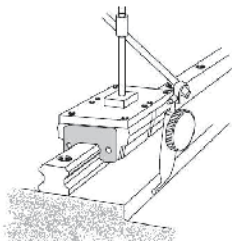

Fig 1.11.19 Use a Temporary Reference Surface

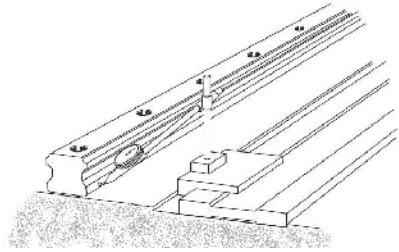

Fig 1.11.20 Use a Straight Edge

Shoulder Heights and Chamfers

Improper shoulder heights and chamfers of mounting surfaces will cause deviations in accuracy and rail or block interference with the chamfered part. When recommended shoulder heights and chamfers are used, problems with installation accuracy should be eliminated.

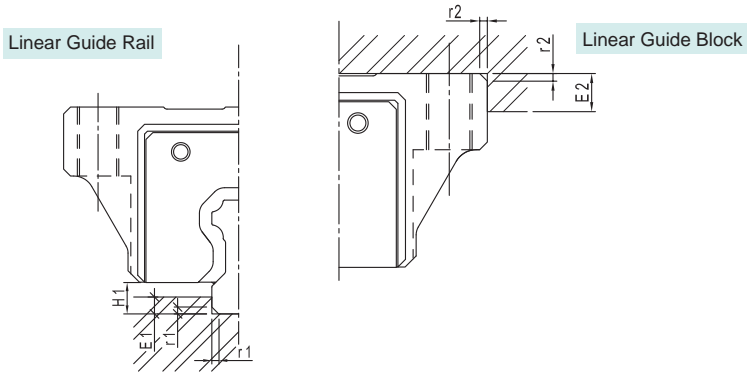

Fig 1.11.21

Table 1.11.4 Shoulder Height and Chamfer

Model No.	Max.chamfer of the rail r1	Max.chamfer of the block r2	Max.chamfer of the rail E1	Max.chamfer of the rail E2	Max.chamfer of the block H1
TR15	0.5	0.5	3	4	3.2
TR20	0.5	0.5	3.5	5	4.6
TR25	1.0	0.9	5	5	5.8
TR30	1.0	1	5	5	7
TR35	1.0	1	6	6	7.5
TR45	1.0	1	8	8	8.9
TR55	1.5	1.5	10	10	13
TR65	1.5	1.5	8	10	14.3

ABOUT LINEAR GUIDE

1-12 Lubrication

Lubrication

Lubrication is essential to linear motion system. Without lubrication, the friction of rolling parts increases and might be the main factor of service life shortening.

A lubricant :

- (1) Reduces friction on moving parts, thereby to prevent wearing due to raise in temperature.
- (2) Forms an oil film on rolling surfaces, thus decreasing stress that develops on the surfaces and safeguarding the system against rolling fatigue.
- (3) Covers metal surfaces with an oil film, thereby preventing rust.

To tap the full function of a linear motion system, lubrication is essential to meet the system service conditions.

※ Even the linear motion system is sealed, it cannot completely prevent the leakage of lubricants no matter how negligible the amount of leakage is at any given time. It is therefore necessary to replenish the lubricant periodically according to the operating conditions.

Classification of Lubricants

Primarily grease and sliding surface oil are used as lubricants for linear motion systems.

In general a lubricant must :

- (1) Form a strong oil film.
- (2) Reduce wear as much as possible.
- (3) Have high wear resistance.
- (4) Have high thermal stability.
- (5) Be non-corrosive.
- (6) Be highly rust-preventive.
- (7) Be free from dust and some moisture.
- (8) Be free from significant fluctuations in consistency against repeated agitation of grease.

Table1.12.1 Lubricants in General Use

Lubricant	Classification	Item
Grease	Lithium-based grease (JIS No.2) Urea-base grease (JIS No.2)	※ 4FB Grease (TBI MOTION) Daphne Eponex Grease No.2 (Idemitsu Kosan) or equivalent.
Oil	Sliding surface oil or turbine oil ISOVG 32~68	Super Multi 32 to 68 (Idemitsu Kosan) Vactra No.2S (Mobile Oil) DT Oil (Mobile Oil) Tonner Oil (Showa Shell Sekiyu) or equivalent

※ Feeding Should be performed every 100 km of travel under normal usage conditions to prevent incomplete lubrication by exhausted lubrication.

1-13 Precautions of Linear Guide

Handling

- (1) Tilting the linear guideway may cause the block falling out from the rail by their own weight.
- (2) Hitting or Dropping the linear guideway may cause its function to be damaged, even if the product looks intact.
- (3) Do not disassemble the block, this may cause contamination to enter into the carriage or decrease the installation accuracy.

Lubrication

- (1) Please remove the anti-rust oil.
- (2) Please do not mix different kinds of lubricants.
- (3) Lubrication can be varied, please consult TBI Motion before use.

Usage

- (1) The temperature of the place where linear guideways are used should not exceed 80°C. A higher temperature may damage the plastic end cap, do not exceed 100°C in friction.
- (2) Using under special conditions, such as constant vibration, high contamination or the temperature exceed our suggested...etc., please contact TBI MOTION.

Storage

When storing the linear guideway, enclose it in a package and store it in a horizontal orientation while avoiding high temperature, low temperature and high humidity.

TBI MOTION LINEAR GUIDE

2-1 The Types of TBI MOTION Linear Guide

In an effort to meet customer's requirement, TBI MOTION offers several different types of guides. Except for TR international standard series, TBI MOTION develops TR series with self lubrication system which is designed for environment with high contamination and miniature TM series for small machines and semiconductor industry.

Table 2.1.1 TBI MOTION Linear guide table with all series

Type	Height of Assembly Type	Square	Flange Mounting from Above, Mounting from Below
TR	High-Assembly	TRH-V	TRH-F
	Low-Assembly	TRS-V	TRS-F
	Middle-Assembly	TRC-V	-

Table 2.1.2 TBI MOTION Linear Guide - Type & Series

Type	Accessory	Characteristics	EndCap
TR	XN : Strong Bottom Seal+Strong Double-lip end seals	Strong dust-proof	Reinforcement Type
	UN : Strong Top Seal+Strong Bottom Seal+Double-lip end seals	Environment with high pollution	
	ZN : Strong Top Seal+Strong Bottom Seal+Strong Two Double-lip end seals		
	WW : Strong Bottom Seal+Felt+Strong Double-lip end seals	Self-lubrication/ Strong dust-proof	
	WU : Strong Top Seal+Strong Bottom Seal+Felt+Strong Double-lip end seals	Application with low rating load	
	WZ : Strong Top Seal+Strong Bottom Seal+Felt+Strong Two Double-lip end seals		
	SU : Strong Top Seal+Strong Bottom Seal+Strong Double-lip end seals+Strong Metal Scraper	Strong dust-proof / Application with low rating load	
	SZ : Strong Top Seal+Strong Bottom Seal+Strong Two Double-lip end seals+Strong Metal Scraper	Self-lubrication/ Strong dust-proof / Application with low rating load	
	DU : Strong Top Seal+Strong Bottom Seal+Strong Double-lip end seals+Felt+Strong Metal Scraper		
	DZ : Strong Top Seal+Strong Bottom Seal+Strong Two Double-lip end seals+Felt+Strong Metal Scraper	Long effects Self-lubrication/ Strong dust-proof	
BN : Strong Bottom Seal+Strong Double-lipendseals+Oil Reservoir			

※If Strengthen seals and Felt is required, please upgrade the block with enhanced end cap.

※Strengthen seals come in blue, if standard seals is required, please order it with code A, EX : XNA.

2-2 TRH / TRS / TRC International Standard Linear Guide

2-2-1 TBI MOTION The Characteristics of TR Series

Smooth Movement

TBI MOTION circulation system of Linear Guide block is designed to perform smooth movement.

High Stability

TBI MOTION Linear Guide block is designed under TBI's exclusive patent that can increase depth of material to improve the strength capacity, prevent deflection and provide high rigidity.

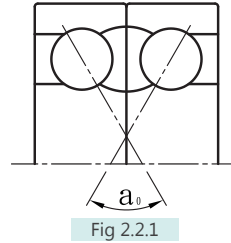

Fig 2.2.1

High Durability

TBI MOTION the exclusive contact point design promotes high rigidity. Moreover, self-aligning balances load rating in all directions. This design also improves performance in running accuracy and service life of the Linear Guide.

Easy Installation with Interchangeability

TBI MOTION Linear Guide is easy for installation even without fixture. The design of seal is able to combine with side seal or inner seal to save material.

2-2-2 The Structure of TR-Series

Circulation unit :

- ① Block, ② Rail, ③ End Cap, ④ Steel Balls,
- ⑤ Circulation tube.

Lubrication unit :

- ⑥ Grease nipple.

Anti-Dust Unit :

- ⑦ End Seal, ⑧ Bottom Seal, ⑨ Mounting Hole Cap.

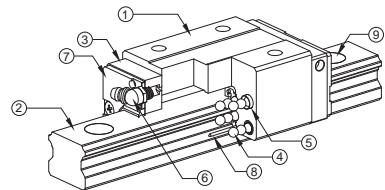

Fig 2.2.2

Fig 2.2.2 Material

Item	Material	Hardness
TR-Rail	S55C	HRC 58°~62°
TR-Block	SCM420H	

TBI MOTION LINEAR GUIDE

2-2 TRH / TRS / TRC International Standard Linear Guide

■ 2-2-3 TR-Series

TBI MOTION offers standard and flange type. The assembly height and category are listed below :

Table 2.2.2

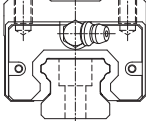
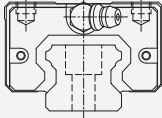
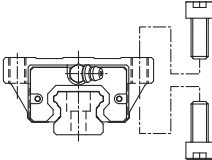
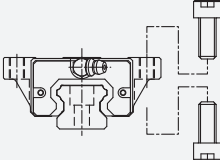
Type	Model	Shape	Height	Rail Length	Main Application
Standard	TRH-V TRC-V	Mounting from Above 	28 ↓ 90	100 ↓ 4000	<ul style="list-style-type: none"> ● Machine Centers. ● NC Lathes. ● Food Machine. ● Grinding Machines. ● CNC Machine. ● Heavy Cutting Machines. ● Punching Machine. ● Injection Molding Machine. ● Automation Equipment. ● Transportation Equipment. ● Sealing machine.
	TRS-V	Mounting from Above 	24 ↓ 60	100 ↓ 4000	
Flange	TRH-F	Mounting from above and below 	24 ↓ 90	100 ↓ 4000	
	TRS-F	Mounting from above and below 	24 ↓ 60	100 ↓ 4000	

A

Linear Guide

■ 2-2-4 Nominal Model Code for Non-interchangeable TR Type

TR series can be classified into interchangeable and non-interchangeable types. The sizes are identical; the only difference between the two types is that the accuracy of non-interchangeable types could reach up to UP grade since **TBI MOTION** makes the linear guide set under strict international regulation. Interchangeable blocks and rails can be freely exchanged; however, the accuracy could be up to H grade only due to technical issue. It is much more convenient for customers who do not need linear guides with high accuracy to have interchange blocks and rails.

Non-interchangeable Type code :

T R H 20 F N - 2 - - 1200 - N - Z0 - II - K + N3 N3

① ② ③ ④ ⑤ ⑥ ⑦ ⑧ ⑨ ⑩ ⑪ ⑫ ⑬ ⑭ ⑮

① Nominal Model	② Block Type	③ Height of Assembly Type	④ Dimension
T	R : Standard X : Special	S : Low-Assembly C : Middle-Assembly H : High-Assembly	15, 20, 25, 30, 35, 45, 55, 65

⑤ Flange Type	⑥ Length of Block	⑦ Number of Block Per Rail	⑧ Accessory Code
F : With Flange V : Without Flange	S : Short N : Normal L : Long E : Extra-Long	EX : 2	□ : Standard (Please refer to page A58)

⑨ Length of Rail	⑩ Accuracy Grade	⑪ Preload	⑫ Two Sets per Axis	⑬ Rail Special Machining
Unit : mm	N : Normal H : High P : Precision SP : Super-Precision UP : Ultra-Precision	ZF : Slight Clearance Z0 : No Preload Z1 : Light Preload Z2 : Medium Preload Z3 : Heavy Preload	II	K : Tapped-Hole Rail X : Rail with Special Machining

⑭ Block Surface Treatment	⑮ Rail Surface Treatment
S : Standard	S : Standard
B1 : Black Oxidation	B1 : Black Oxidation
N1 : Hard Chrome Plating	N1 : Hard Chrome Plating
P : Phosphating	P : Phosphating
N3 : Nickel Plating	N3 : Nickel Plating
N4 : Raydent	N4 : Raydent
N5 : Chrome Plating	N5 : Chrome Plating

※ No symbol required when plating is not needed.

TBI MOTION LINEAR GUIDE

2-2 TRH / TRS / TRC International Standard Linear Guide

■ 2-2-5 Nominal Model Code for Interchangeable TR Type

Interchangeable Type of Block :

T R H 20 F N - [] - N - Z0 + B1

① ② ③ ④ ⑤ ⑥ ⑦ ⑧ ⑨ ⑩

①	②	③	④
Nominal Model	Block Type	Height of Assembly Type	Dimension
T	R : Standard X : Special	S : Low-Assembly C : Middle-Assembly H : High-Assembly	15, 20, 25, 30, 35, 45, 55, 65

⑤	⑥	⑦	⑧	⑨
Flange Type	Length of Block	Accessory Code	Accuracy Grade	Preload
F : With Flange V : Without Flange	S : Short N : Normal L : Long E : Extra-Long	□ : Standard	N : Normal	ZF : Slight Clearance Z0 : No Preload

⑩
Block Surface Treatment
□ : Standard
B1 : Black Oxidation
N1 : Hard Chrome Plating
P : Phosphating
N3 : Nickel Plating
N4 : Raydent
N5 : Chrome Plating

Interchangeable Type of Rail :

T R 20 - 4000 - N - K + B1

① ② ③ ④ ⑤ ⑥ ⑦

① Nominal Model	② Block Type	③ Dimension	④ Length of Rail
T	R : Standard X : Special	15, 20, 25, 30, 35, 45, 55, 65	Unit : mm

⑤ Accuracy Grade	⑥ Rail Special Machining	⑦ Block Surface Treatment
N : Normal	K : Tapped-Hole Rail X : Rail with Special Machining	□ : Standard B1 : Black Oxidation N1 : Hard Chrome Plating P : Phosphating N3 : Nickel Plating N4 : Raydent N5 : Chrome Plating

TBI MOTION LINEAR GUIDE

2-2 TRH / TRS / TRC International Standard Linear Guide

TRH-V Series Specifications

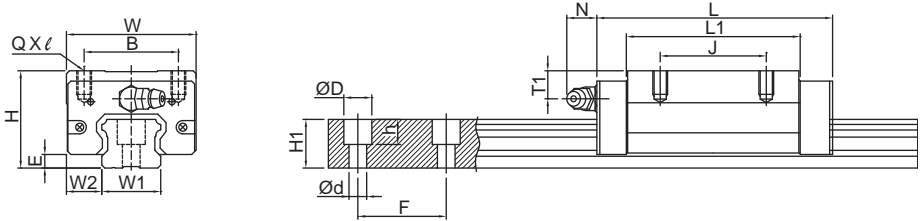

A

Linear Guide

Model No.	Assembly (mm)			Block Dimension (mm)							Rail (mm)							
	H	W2	E	W	B	J	L	L1	QXℓ	T1	Oil Hole	N	W1	H1	ØD	h	Ød	F
TRH15VN	28	9.5	3.2	34	26	26	56.9	39.5	M4X8	9.5	M4X0.7	7	15	13	7.5	6	4.5	60
TRH15VL							65.4	48										
TRH20VN	30	12	4.6	44	32	36	75.6	54	M5X7	6.5	M6X1	14	20	16.5	9.5	8.5	6	60
TRH20VE						50	99.6	78										
TRH25VN	40	12.5	5.8	48	35	35	81	59	M6X8	11.5	M6X1	14	23	20	11	9	7	60
TRH25VE						50	110	88										
TRH30VN	45	16	7	60	40	40	96.3	69.3	M8X10	11	M6X1	14	28	23	14	12	9	80
TRH30VE						60	132	105										
TRH35VN	55	18	7.5	70	50	50	109	79	M8X10	15	M6X1	14	34	26	14	12	9	80
TRH35VE						72	153	123										
TRH45VL	70	20.5	8.9	85.5	60	60	140	106	M10X15	20.5	PT1/8	12.5	45	32	20	17	14	105
TRH45VE						80	174	140										
TRH55VL	80	23.5	13	100	75	75	162	118	M12X18	21	PT1/8	12.5	53	44	23	20	16	120
TRH55VE						95	200.1	156.1										
TRH65VL	90	31.5	14	126	76	70	197	147	M16X20	19	PT1/8	12.5	63	53	26	22	18	150
TRH65VE						120	256.5	206.5										

※The above specifications provided are dedicated to XN, UN, please check table 2.2.17 for detail, if other accessories is required, please refer to page A87.

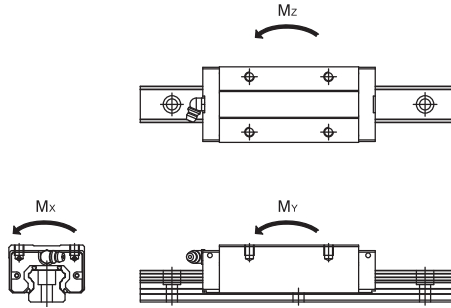

Model No.	Load Rating (kgf)		Static Permissible Moment					Weight	
			Mx (kgf-mm)		My (kgf-mm)		Mz (kgf-mm)		Block (kg)
	C	Co	Single Block	Single Block	Double Block	Single Block	Double Block		
TRH15VN	1206	2206	16,436	14,884	70,960	14,884	70,960	0.15	1.32
TRH15VL	1343	2574	19,175	20,429	95,224	20,429	95,224	0.22	
TRH20VN	2050	3696	37,334	33,268	157,298	33,268	157,298	0.31	2.28
TRH20VE	2553	5058	51,089	63,229	284,163	63,229	284,163	0.44	
TRH25VN	2581	4503	52,239	43,407	207,324	43,407	207,324	0.52	3.17
TRH25VE	3248	6255	72,554	85,112	391,311	85,112	391,311	0.77	
TRH30VN	3807	6483	90,722	74,970	355,321	74,970	355,321	0.85	4.54
TRH30VE	4791	9004	126,003	147,000	677,068	147,000	677,068	1.3	
TRH35VN	5090	8346	142,722	106,070	519,799	106,070	519,799	1.47	6.27
TRH35VE	6667	12274	209,885	233,977	1,070,533	233,977	1,070,533	2.26	
TRH45VL	7572	12808	292,657	220,751	1,030,183	220,751	1,030,183	3.00	10.4
TRH45VE	8852	16010	365,821	348,554	1,598,703	348,554	1,598,703	3.90	
TRH55VL	14703	21613	571,342	411,729	2,019,184	411,729	2,019,184	4.42	16.1
TRH55VE	17349	27377	723,699	670,530	3,148,637	670,530	3,148,637	5.50	
TRH65VL	22526	31486	973,074	695,840	3,594,277	695,840	3,594,277	8.66	22.54
TRH65VE	27895	42731	1,320,601	1,307,568	6,312,759	1,307,568	6,312,759	10.30	

TBI MOTION LINEAR GUIDE

2-2 TRH / TRS / TRC International Standard Linear Guide

TRH-F Series Specifications

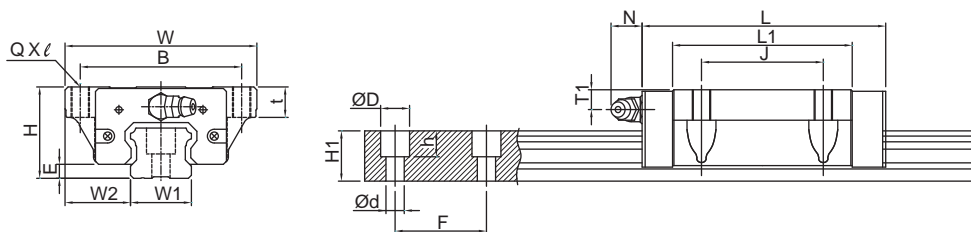

A

Linear Guide

Model No.	Assembly (mm)			Block Dimension (mm)										Rail (mm)					
	H	W2	E	W	B	J	t	L	L1	QXℓ	T1	Oil Hole	N	W1	H1	ØD	h	Ød	F
TRH15FN	24	16	3.2	47	38	30	8	56.9	39.5	M5X8	5.5	M4X0.7	7	15	13	7.5	6	4.5	60
TRH15FL								65.4	48										
TRH20FN	30	21.5	4.6	63	53	40	10	75.6	54	M6X10	6.5	M6X1	14	20	16.5	9.5	8.5	6	60
TRH20FE								99.6	78										
TRH25FN	36	23.5	5.8	70	57	45	12	81	59	M8X12	7.5	M6X1	14	23	20	11	9	7	60
TRH25FE								110	88										
TRH30FN	42	31	7	90	72	52	15	96.3	69.3	M10X15	8	M6X1	14	28	23	14	12	9	80
TRH30FE								132	105										
TRH35FN	48	33	7.5	100	82	62	15	109	79	M10X15	8	M6X1	14	34	26	14	12	9	80
TRH35FE								153	123										
TRH45FL	60	37.5	8.9	120	100	80	18	140	106	M12X18	10.5	PT1/8	12.5	45	32	20	17	14	105
TRH45FE								174	140										
TRH55FL	70	43.5	13	140	116	95	29	162	118	M14X17	11	PT1/8	12.5	53	44	23	20	16	120
TRH55FE								200.1	156.1										
TRH65FL	90	53.5	14	170	142	110	37	197	147	M16X23	19	PT1/8	12.5	63	53	26	22	18	150
TRH65FE								256.5	206.5										

※The above specifications provided are dedicated to XN, UN, please check table 2.2.17 for detail, if other accessories is required, please refer to page A87.

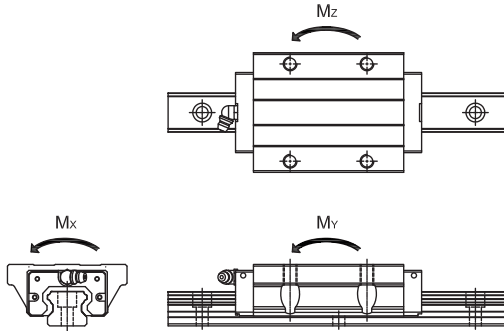

Model No.	Load Rating (kgf)		Static Permissible Moment					Weight	
			Mx (kgf-mm)		My (kgf-mm)		Mz (kgf-mm)		Block (kg)
	C	Co	Single Block	Single Block	Double Block	Single Block	Double Block		
TRH15FN	1206	2206	16,436	14,884	70,960	14,884	70,960	0.18	1.32
TRH15FL	1343	2574	19,175	20,429	95,224	20,429	95,224	0.22	
TRH20FN	2050	3696	37,334	33,268	157,298	33,268	157,298	0.39	2.28
TRH20FE	2553	5058	51,089	63,229	284,163	63,229	284,163	0.58	
TRH25FN	2581	4503	52,239	43,407	207,324	43,407	207,324	0.60	3.17
TRH25FE	3248	6255	72,554	85,112	391,311	85,112	391,311	0.85	
TRH30FN	3807	6483	90,722	74,970	355,321	74,970	355,321	1.01	4.54
TRH30FE	4791	9004	126,003	147,000	677,068	147,000	677,068	1.54	
TRH35FN	5090	8346	142,722	106,070	519,799	106,070	519,799	1.47	6.27
TRH35FE	6667	12274	209,885	233,977	1,070,533	233,977	1,070,533	2.29	
TRH45FL	7572	12808	292,657	220,751	1,030,183	220,751	1,030,183	2.80	10.4
TRH45FE	8852	16010	365,821	348,554	1,598,703	348,554	1,598,703	3.79	
TRH55FL	14703	21613	571,342	411,729	2,019,184	411,729	2,019,184	4.22	16.1
TRH55FE	17349	27377	723,699	670,530	3,148,637	670,530	3,148,637	5.6	
TRH65FL	22526	31486	973,074	695,840	3,594,277	695,840	3,594,277	9.31	22.54
TRH65FE	27895	42731	1,320,601	1,307,568	6,312,759	1,307,568	6,312,759	12.98	

TBI MOTION LINEAR GUIDE

2-2 TRH / TRS / TRC International Standard Linear Guide

TRS-V Series Specifications

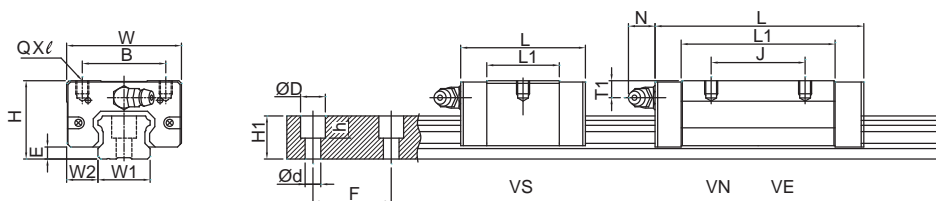

A

Linear Guide

Model No.	Assembly(mm)			Block Dimension(mm)								Rail(mm)						
	H	W2	E	W	B	J	L	L1	QXl	T1	Oil Hole	N	W1	H1	ØD	h	Ød	F
TRS15VS	24	9.5	3.2	34	26	40.3	22.9	M4X5	5.5	M4X0.7	7	15	13	7.5	6	4.5	60	
TRS15VN						26	56.9											39.5
TRS20VS	28	11	4.6	42	32	49.4	27.8	M5X6	4.5	M6X1	14	20	16.5	9.5	8.5	6	60	
TRS20VN						32	68.3											46.7
TRS25VS	33	12.5	5.8	48	35	57.2	35.2	M6X6.5	4.5	M6X1	14	23	20	11	9	7	60	
TRS25VN						35	81											59
TRS30VS	42	16	7	60	40	67.4	40.4	M8X8	8	M6X1	14	28	23	14	12	9	80	
TRS30VN						40	96.3											69.3
TRS35VN	48	18	7.5	70	50	50	109	79	M8X8	8	M6X1	14	34	26	14	12	9	80
TRS35VE						72	153	123										
TRS45VN	60	20.5	8.9	86	60	60	124.5	90.5	M10X15	10.5	PT1/8	12.5	45	32	20	17	14	105

※The above specifications provided are dedicated to XN, UN, please check table 2.2.17 for detail, if other accessories is required, please refer to page A87.

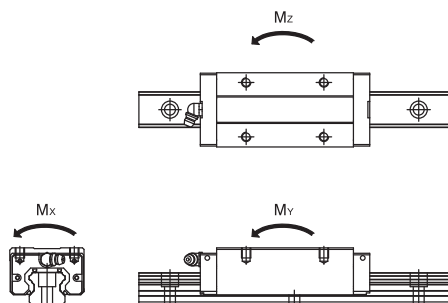

Model No.	Load Rating (kgf)		Static Permissible Moment					Weight	
			Mx (kgf-mm)	My (kgf-mm)		Mz (kgf-mm)		Block (kg)	Rail (kg/m)
	C	Co	Single Block	Single Block	Double Block	Single Block	Double Block		
TRS15VS	908	1471	10,957	6,420	33,531	6,420	33,531	0.09	1.32
TRS15VN	1206	2206	16,436	14,884	70,960	14,884	70,960	0.15	
TRS20VS	1398	2140	21,615	10,700	59,798	10,700	59,798	0.15	2.28
TRS20VN	1896	3307	33,404	26,459	126,998	26,459	126,998	0.23	
TRS25VS	1943	3002	34,826	18,725	97,890	18,725	97,890	0.25	3.17
TRS25VN	2581	4503	52,239	43,407	207,324	43,407	207,324	0.39	
TRS30VS	2697	3962	55,442	26,950	154,224	26,950	154,224	0.48	4.54
TRS30VN	3807	6483	90,722	74,970	355,321	74,970	355,321	0.77	
TRS35VN	5090	8346	142,722	106,070	519,799	106,070	519,799	1.15	6.27
TRS35VE	6667	12274	209,885	233,977	1,070,533	233,977	1,070,533	1.54	
TRS45VN	6758	10887	248,758	158,011	782,271	158,011	782,271	1.98	10.4

TBI MOTION LINEAR GUIDE

2-2 TRH / TRS / TRC International Standard Linear Guide

TRS-F Series Specifications

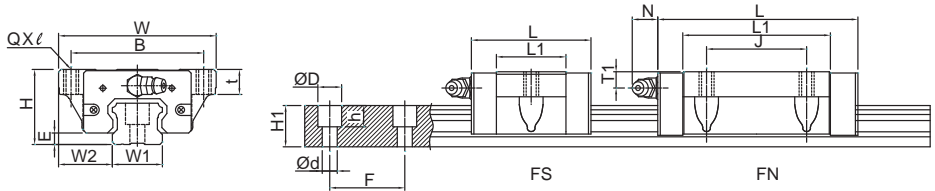

Model No.	Assembly(mm)			Block Dimension(mm)										Rail(mm)					
	H	W2	E	W	B	J	t	L	L1	QXℓ	T1	Oil Hole	N	W1	H1	ØD	h	Ød	F
TRS15FS	24	18.5	3.2	52	41	26	7	40.3	22.9	M5X7	5.5	M4X0.7	7	15	13	7.5	6	4.5	60
TRS15FN								56.9	39.5										
TRS20FS	28	19.5	4.6	59	49	32	9	49.4	27.8	M6X9	4.5	M6X1	14	20	16.5	9.5	8.5	6	60
TRS20FN								68.3	46.7										
TRS25FN	33	25	5.8	73	60	35	10	81	59	M8X10	4.5	M6X1	14	23	20	11	9	7	60

※ The above specifications provided are dedicated to XN, UN, please check table 2.2.17 for detail, if other accessories is required, please refer to page A87.

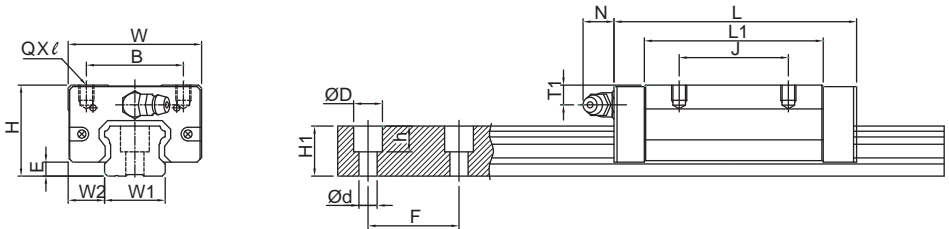

Model No.	Assembly(mm)			Block Dimension(mm)										Rail(mm)					
	H	W2	E	W	B	J	L	L1	QXℓ	T1	Oil Hole	N	W1	H1	ØD	h	Ød	F	
TRC25VE	36	12.5	5.8	48	35	50	110	88	M6X6.5	7.5	M6X1	14	23	20	11	9	7	60	

※ The above specification provided is dedicated to XN, UN, please check table 2.2.17 for detail, if other accessories is required, please refer to page A87.

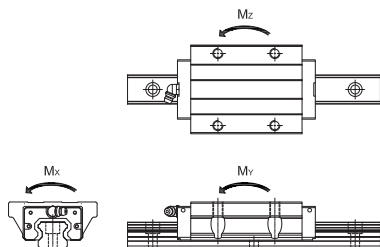

Model No.	Load Rating (kgf)		Static Permissible Moment					Weight	
			Mx (kgf-mm)	My (kgf-mm)		Mz (kgf-mm)		Block (kg)	Rail (kg/m)
	C	Co		Single Block	Single Block	Double Block	Single Block		
TRS15FS	908	1471	10,957	6,420	33,531	6,420	33,531	0.12	1.32
TRS15FN	1206	2206	16,436	14,884	70,960	14,884	70,960	0.19	
TRS20FS	1398	2140	21,615	10,700	59,798	10,700	59,798	0.19	2.28
TRS20FN	1896	3307	33,404	26,459	126,998	26,459	126,998	0.29	
TRS25FN	2581	4503	52,239	43,407	207,324	43,407	207,324	0.51	3.17

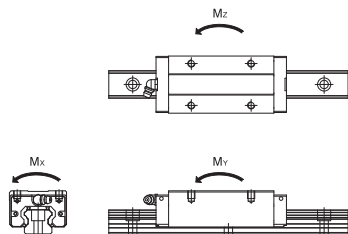

Model No.	Load Rating (kgf)		Static Permissible Moment					Weight	
			Mx (kgf-mm)	My (kgf-mm)		Mz (kgf-mm)		Block (kg)	Rail (kg/m)
	C	Co		Single Block	Single Block	Double Block	Single Block		
TRC25VE	3248	6255	72,554	85,112	391,311	85,112	391,311	0.65	3.17

TBI MOTION LINEAR GUIDE

2-2 TRH / TRS / TRC International Standard Linear Guide

2-2-6 The Standard Length and Maxima Length of Linear Rail

TBI MOTION offer our customers standard and customized rail length to meet the requirement of our customers. TBI suggests that when ordering customized rail length, to prevent unstable running performance after mounting, the end cap value G should be no greater than 1/2F.

$$L = [n-1] \cdot F + 2 \cdot G$$

L : Total Length of Rail (mm)

n : Number of Mounting Holes

F : Distance Between Any Two Holes (mm)

G : Distance from the Center of the Last Hole to the Edge (mm)

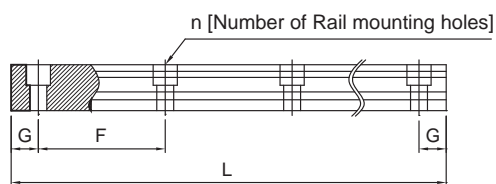

Fig 2.2.3

Table 2.2.3

Item	TR15	TR20	TR25	TR30	TR35	TR45	TR55	TR65
F : Pitch	60	60	60	80	80	105	120	150
G : Suggested Distance to End	20	20	20	20	20	22.5	30	35
L : Max. Length	4000	4000	4000	4000	4000	4000	4000	4000

2-2-7 Mounting Type of Linear Rail

Besides the standard top mounting type, *TBI MOTION* also offers bottom mounting type rails.

Table 2.2.4

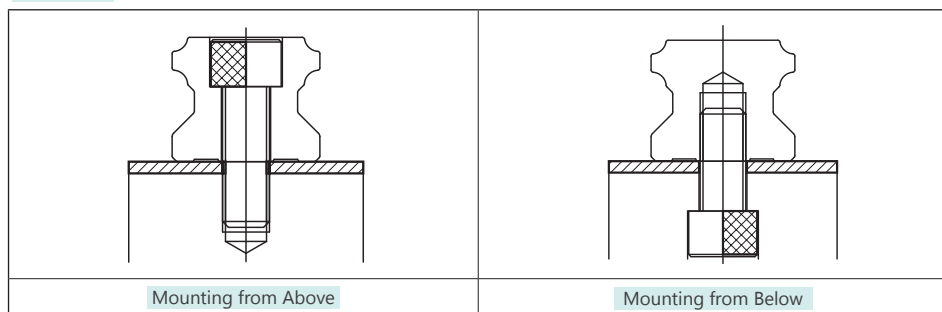

Mounting from Above

Mounting from Below

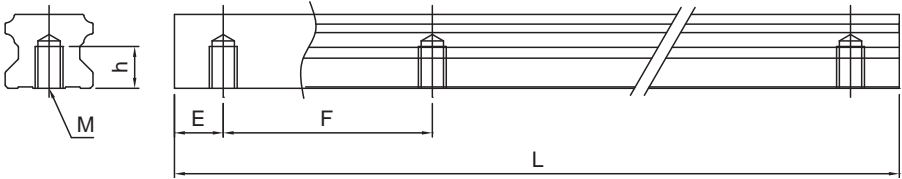

Fig 2.2.4 Mounting from below

Table 2.2.5 Rail Size Chart

Unit : mm

	M	h	E	F
TR15	M5 · 0.8	8	20	60
TR20	M6 · 1	10	20	60
TR25	M6 · 1	12	20	60
TR30	M8 · 1.25	15	20	80
TR35	M8 · 1.25	17	20	80
TR45	M12 · 1.75	24	22.5	105
TR55	M14 · 2	24	30	120
TR65	M20 · 2.5	30	35	150

2-2 TRH / TRS / TRC International Standard Linear Guide

■ 2-2-8 Accuracy Standard

The accuracy standards of TR-Series range, from normal (N), high (H), precision (P), super-precision (SP) and ultra-precision (UP). It allows our user to choose according to the accuracy standards of the equipment.

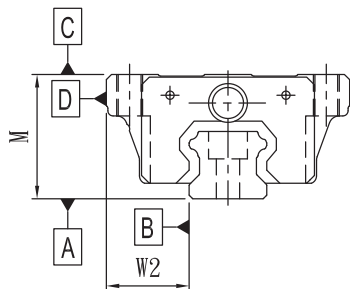
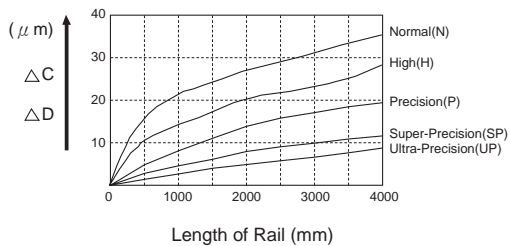

Fig 2.2.5 Accuracy Standard



TR Rail Length and Running Accuracy.

Fig 2.2.6

Table 2.2.6 TR-Accuracy of Running Parallelism

TR Rail Length (mm)	Accuracy (μm)				
	N	H	P	SP	UP
0~125	5	3	2	1.5	1
125~200	5	3.5	2	1.5	1
200~250	6	4	2.5	1.5	1
250~315	7	4.5	3	1.5	1
315~400	8	5	3.5	2	1.5
400~500	9	6	4.5	2.5	1.5
500~630	16	11	6	2.5	1.5
630~800	18	12	7	3	2
800~1000	20	14	8	4	2
1000~1250	22	16	10	5	2.5
1250~1600	25	18	11	6	3
1600~2000	28	20	13	7	3.5
2000~2500	30	22	15	8	4
2500~3000	32	24	16	9	4.5
3000~3500	33	25	17	11	5
3500~4000	34	26	18	12	6

Table 2.2.7

Unit : mm

Accuracy Standard										
TR 15 20						TR 25 30 35				
Accuracy Standard	Normal	High	Precision	Super Precision	Ultra Precision	Normal	High	Precision	Super Precision	Ultra Precision
Item	N	H	P	SP	UP	N	H	P	SP	UP
Tolerance for height M	±0.1	±0.03	0 -0.03	0 -0.015	0 -0.008	±0.1	±0.04	0 -0.04	0 -0.02	0 -0.01
Tolerance for height M difference among Linear Guide Block	0.02	0.01	0.006	0.004	0.003	0.02	0.015	0.007	0.005	0.003
Tolerance for rail-to-block lateral distance W2	±0.1	±0.03	0 -0.03	0 -0.015	0 -0.008	±0.1	±0.04	0 -0.04	0 -0.02	0 -0.01
Tolerance for rail-to-block lateral distance W2 difference among Linear Guide Block	0.02	0.01	0.006	0.004	0.003	0.03	0.015	0.007	0.005	0.003
Running parallelism of Linear Guide Block surface [C] with respect to surface [A]	Δ C, TR Rail Length and Running Accuracy (Fig 2.2.5)					Δ C, TR Rail Length and Running Accuracy (Fig 2.2.5)				
Running parallelism of Linear Guide Block surface [D] with respect to surface [B]	Δ D, TR Rail Length and Running Accuracy (Fig 2.2.5)					Δ D, TR Rail Length and Running Accuracy (Fig 2.2.5)				
Accuracy Standard										
TR 45 55						TR 65				
Accuracy Standard	Normal	High	Precision	Super Precision	Ultra Precision	Normal	High	Precision	Super Precision	Ultra Precision
Item	N	H	P	SP	UP	N	H	P	SP	UP
Tolerance for height M	±0.1	±0.05	0 -0.05	0 -0.03	0 -0.02	±0.1	±0.07	0 -0.07	0 -0.05	0 -0.03
Tolerance for height M difference among Linear Guide Block	0.03	0.015	0.007	0.005	0.003	0.03	0.02	0.01	0.007	0.005
Tolerance for rail-to-block lateral distance W2	±0.1	±0.05	0 -0.05	0 -0.03	0 -0.02	±0.1	±0.07	0 -0.07	0 -0.05	0 -0.03
Tolerance for rail-to-block lateral distance W2 difference among Linear Guide Block	0.03	0.02	0.01	0.007	0.005	0.03	0.025	0.015	0.01	0.007
Running parallelism of Linear Guide Block surface [C] with respect to surface [A]	Δ C, TR Rail Length and Running Accuracy (Fig 2.2.5)					Δ C, TR Rail Length and Running Accuracy (Fig 2.2.5)				
Running parallelism of Linear Guide Block surface [D] with respect to surface [B]	Δ D, TR Rail Length and Running Accuracy (Fig 2.2.5)					Δ D, TR Rail Length and Running Accuracy (Fig 2.2.5)				

TBI MOTION LINEAR GUIDE

2-2 TRH / TRS / TRC International Standard Linear Guide

■ 2-2-9 Determining the Magnitude of a Preload

What's Preload

Using larger rolling elements helps strengthen the entire rigidity of the block while there exists clearance within ball circulation.

Increasing preload would decrease the vibration and reduce the corrosion caused by running back and forth. However, it would also add the workload within those rolling elements. The greater the preload is, the greater the inner workload is. Therefore, choosing preload has to consider the effect carefully between vibration and preload.

Table 2.2.8 Preload Grade

C : Dynamic load rating

Grade	Symbol	Preload Force
Slight Clearance	ZF	0
No Preload	Z0	0
Light Preload	Z1	0.02C
Medium Preload	Z2	0.05C
Heavy Preload	Z3	0.07C

Table 2.2.9 TR Series Radial Clearances

Unit : μm

Preload Model No.	ZF	Z0	Z1	Z2	Z3
TR15	5~12	-4~4	-12~-5	-20~-13	-28~-21
TR20	6~14	-5~5	-14~-6	-23~-15	-32~-24
TR25	7~16	-6~6	-16~-7	-26~-17	-36~-27
TR30	8~18	-7~7	-18~-8	-29~-19	-40~-30
TR35	9~20	-8~8	-20~-9	-32~-21	-44~-33
TR45	10~22	-9~9	-22~-10	-35~-23	-48~-36
TR55	11~24	-10~10	-24~-11	-38~-25	-52~-39
TR65	12~26	-11~11	-26~-12	-41~-27	-56~-42

Table 2.2.10 The Difference between Interchangeability and Non-Interchangeability

Slight Clearance	Non-Interchangeable					Interchangeable
	UP	SP	P	H	N	N
Preload			Z0	Z0	ZF	ZF
	Z1	Z1	Z1	Z1	Z0	Z0
	Z2	Z2	Z2	Z2	Z1	Z1
	Z3	Z3	Z3	Z3	Z2	

■ 2-2-10 Mounting Location of Grease Nipples

The standard location of the grease nipple is at both ends of the block, but the nipple can be mounted at each side of block. For lateral installation, we recommend that the nipple be mounted at the non-reference side, otherwise please contact us. It is possible to perform lubrication by using the oil-piping joint.

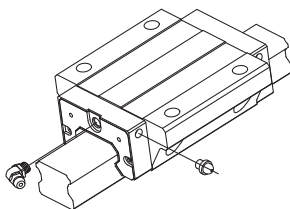

Fig 2.2.7 Mounting Location

Table 2.2.11 The Lubricant Amount for a Block Filled with Grease

Size	Grease (cm ³)
TR15	1.3
TR20	2.5
TR25	2.5
TR30	7
TR35	9
TR45	15.2
TR55	40
TR65	75

Table 2.2.12 Oil Refilling Rate

Size	Oil refilling rate (cm ² /hr)
TR15	0.2
TR20	0.2
TR25	0.3
TR30	0.3
TR35	0.3
TR45	0.4
TR55	0.5
TR65	0.6

TBI MOTION LINEAR GUIDE

2-2 TRH / TRS / TRC International Standard Linear Guide

■ 2-2-11 Grease Nipples

Table 2.2.13 Grease Nipples

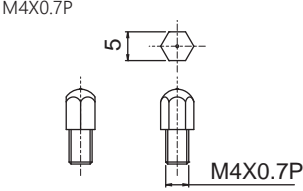
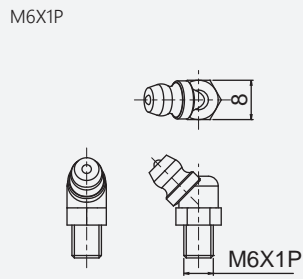
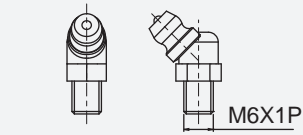
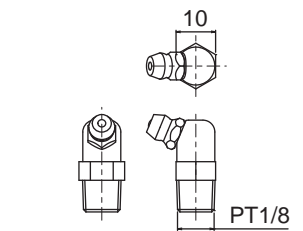
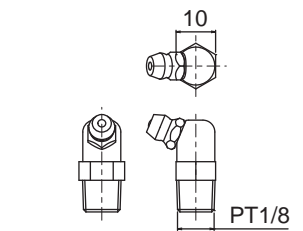
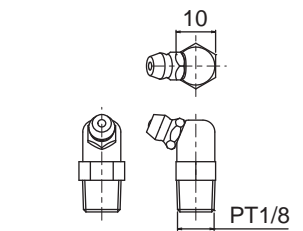
Model	Accessory Code	Grease Nipple Code	Size
TR15	XN, UN	SD-020	
	SU, ZN	SD-024	
	SZ	SD-066	
	WW, WU, WZ, DU, DZ	-	
TR20 TR25 TR30	XN, UN	SD-021	
	SU	SD-025	
	SZ	SD-026	
	ZN	SD-075	
	WW, WU, WZ, DU, DZ	-	
TR35	XN, UN	SD-021	
	SU, ZN	SD-026	
	SZ	SD-060	
	WW, WU, WZ, DU, DZ	-	
TR45	XN, UN	SD-011	
	SZ, ZN	SD-027	
	SU	SD-068	
	WW, WU, WZ, DU, DZ	-	
TR55	XN, UN	SD-011	
	SZ, ZN	SD-059	
	SU	SD-068	
	WW, WU, WZ	-	
TR65	XN, UN	SD-011	
	SU	SD-059	
	SZ, ZN	SD-058	
	WW, WU, WZ	-	

A

Linear Guide

Table 2.2.14 Types of Lubrication Coupler

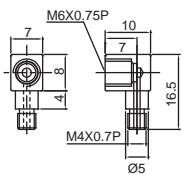
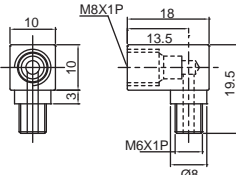
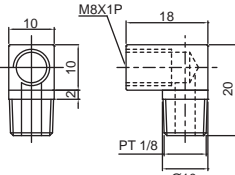
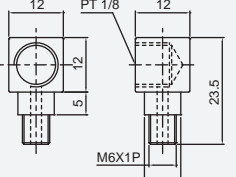
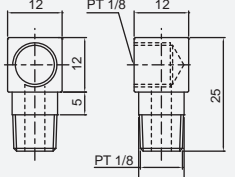
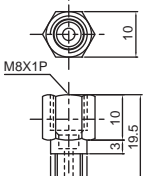
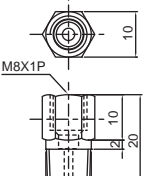
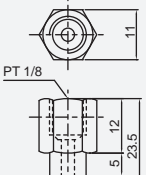
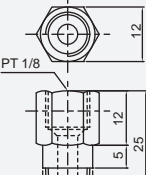
Model	TR15	TR20, 25, 30, 35	TR45, 55, 65
Types of Lubrication Coupler	<p>SD-037</p> 	<p>SD-038</p> 	<p>SD-039</p> 
		<p>SD-029</p> 	<p>SD-040</p> 
		<p>SD-041</p> 	<p>SD-042</p> 
		<p>SD-043</p> 	<p>SD-044</p> 

TBI MOTION LINEAR GUIDE

2-2 TRH / TRS / TRC International Standard Linear Guide

■ 2-2-12 J-Flow System

When the linear guide sets up on the side mount as the (Fig 2.2.8) shows. It is hard to equally distribute the lubrication on the race groove due to gravity. The common way to solve this is to grease from the side of the block; however, such method is almost impossible when the application is already space limited. TBI Motion provides a unique solution to overcome the dilemma by implementing the J-Flow System. The J-Flow System is equipped with two optional screw-tightening lubrication spot on both ends of linear block with the special internal lubricating path which allows the lubrication to travel in both direction by simply tightening or loosening the lubrication screw.

A

Linear Guide

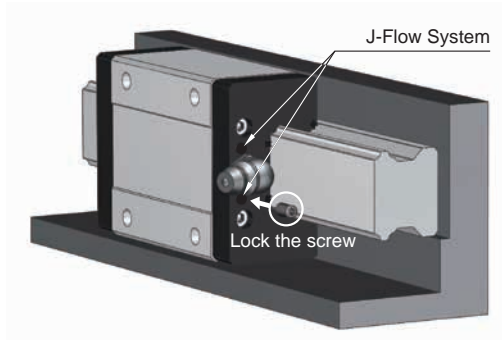

Fig 2.2.8 J-Flow System

The oil flows upward

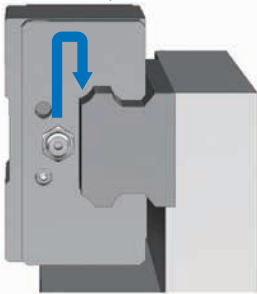

Fig 2.2.9 The oil sail against the gravity to lubricate the circulation path

When stop, slowly shed

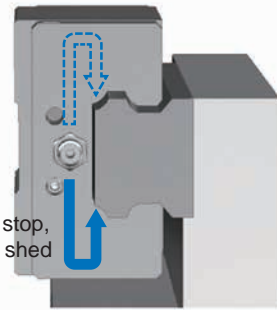

Fig 2.2.10 The oil flows downward through optional screw in spot when the feeding stops

■ 2-2-13 Strong Dust-proof/Self-Lubricating Linear Guide Series Accessory

TBI MOTION Linear Guide with Double-lip End Seal

Characteristics of *TBI MOTION* Dust-proof End Seal

1. Seal Function : Seal design from single-lip to double-lip is to prevent more dust from going into the block.
2. Hardness : Heat treatment harden the end seal to absorb impact while operating.
3. Environment : Better solution for dust-proof when using double seals in environment with high contamination.
4. Lifetime Extension : Double-lip seal prevents dust go into the block and provides a solution for block damage due to dust issue.

Characteristics of *TBI MOTION* Metal Scraper

The scraper decreases the possibility of high temperature iron chip or dust entering the block.

Characteristics of *TBI MOTION* Self-Lubricating Linear Guide Series

There is a Felt accessory between end cap and seals. Felt with oil lubricates the rail when operating and grease nipple is not needed. The design is shown below. (Fig 2.2.11)

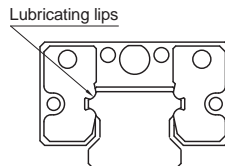

Fig 2.2.11

Example

WZ (Top Seal+Bottom Seal+Two Double-lip end seals+Felt)

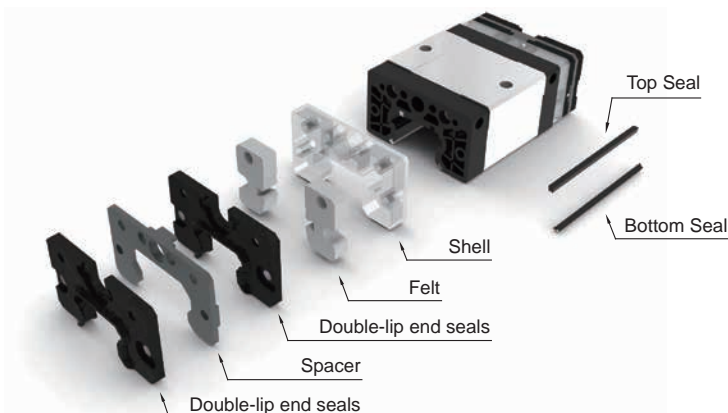

Fig 2.2.12

TBI MOTION LINEAR GUIDE

2-2 TRH / TRS / TRC International Standard Linear Guide

Life Comparison

As shown in the chart, the lifetime of self-lubricating blocks is twice as long as standard series blocks.

Table 2.2.15 Test

	Control Group	Experiment Group
Test Environment	Standard	Self-Lubricating
Model No.	TRH20VN	TRH20VN
Load Rating	1000 kg	1000 kg
Speed	6 m/min	6 m/min
Travel Length	600 mm	600 mm

※ No extra grease is added during the test for both standard series and self-lubricating series.

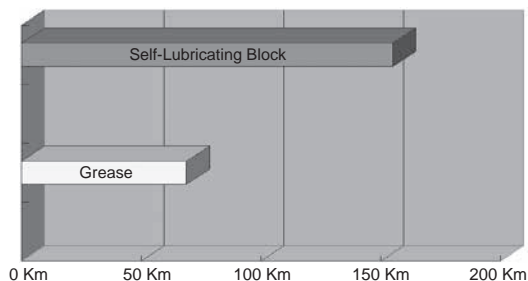
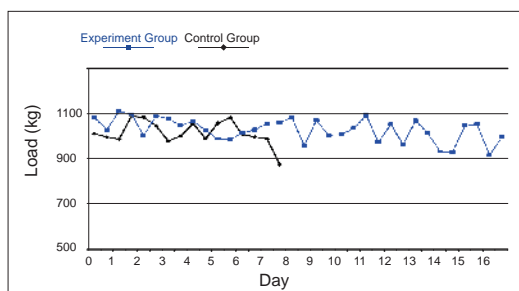

A

Linear Guide

Instructions of Self-Lubricating Block Felt

The felt has already filled in with lubricant. It is suggested to soak the whole felt in the oil tank for more than 8 hours before using. Felt can be refilled with any approved lubricant depending on the requirement (ISOVG 32~68).

Characteristics of Suggested Oil :

- (1) Form a strong oil film.
- (2) Reduce wear as much as possible.
- (3) Have high wear resistance.
- (4) Have high thermal stability.
- (5) Be noncorrosive.
- (6) Be highly rust-preventive.
- (7) Be free from dust and some moisture.

Characteristics of Block Felt

- (1) Easy Assembly and Removal - Only screws are needed when assembling and disassembling the accessory.
- (2) Environmental Friendly - No need of grease nipple and other equipment to save energy.
- (3) Low Maintenance - Prevents oil leaking, making it a ideal solution for clean working environments.
- (4) Strong Dust-Proof - With dust-proof accessory, service life is extended.

The Suggested Operating Temperature

The suggested operating temperature is between -10°C to 60°C. If operating temperature is over suggested criteria, please contact TBI MOTION.

2-2 TRH / TRS / TRC International Standard Linear Guide

Self-Lubricating Linear Guide Oil Cassette Units

Self lubrication system is designed with lubrication mechanism between end cap and wiper. The structure units are shown as follow. The Cassette unit is comprised with fluid channel which is soaked with oil and act to release the lubricants thoroughly during operation. With this smart and simple design, the linear guide can be lubricated without extra oil feeding units thus minimize unnecessary parts and waste which triggers higher cost and higher risk in mounting error.

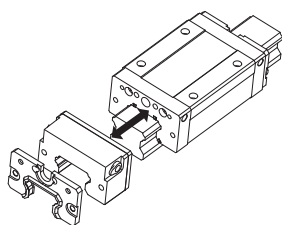

Fig 2.2.13 Installation Method

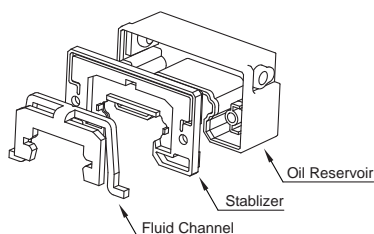

Fig 2.2.14 Cassette Unit

Characteristics of Self-Lubricating Units

- (1) No extra oil feeding unit is required.
- (2) Applicable in highly required clean environment.
- (3) May maintain lubrication for a period of time.
- (4) Lubricates thoroughly in any operating positions.
- (5) Interchangeable to any grease/oil.
- (6) Improves dust-proof efficiency when assembled to the block.

Applications

- (1) Machine Tool
- (2) Industrial Automation : Plastic and rubber manufacturers, Typography, Paper, Textiles, Food.
- (3) Electronic and Component manufacturing : Semiconductor, X-Y Platform, Measurement, Equipment
- (4) Others : Medical Equipment, Conveyers

Characteristics of Lubrication Oil

The Self lubrication cassette is filled in with Synthetic Hydro Carbon oil (SHC). The performance of the oil is list as follows :

- (1) Solvent refined oil without wax and impurity.
- (2) High grade of consistency in extreme temperature.
- (3) Corrosion free to metal and high polymer.
- (4) Unique woven texture provides oil film on the contact point to prevent wear.
- (5) High chemical stability and durability.

Table 2.2.16

Character	Color		Clear Yellow
Ratio	15/4°C		0.860
Viscosity	100°C	c S t	137.47
	40°C		1570.68
Viscosity Index	—		120
Fluid	°C		-30
Flash Point	°C		243
Evaporation Rate	100°C · 24 hr		<0.15%
Copper Corrosion Test	100°C · 24 hr		Pass
Resin Test	80°C · 24 hr Polystyrene		Pass
Operation Temperature (°C)			-30~160

2-2 TRH / TRS / TRC International Standard Linear Guide

■ 2-2-14 Dust-proof/Accessory

If the following accessories are needed, please add the code followed by the model number.

Special Option : Steel end seal, Steel end cap, Cover Strip, please contact TBI Motion.

Standard Accessories :

End seal and Bottom seal

To prevent life reduction caused by iron chips or dust entering the block.

Other Accessories :

Top Seal

Efficiently prevents dust from the surface of rail or tapping hole getting inside the block.

Double end seal

Enhances the wiping effect, foreign matter can be completely wiped off.

Double-lip end seals

Double-lip end seal is suitable for environment with high contamination.

Characteristics of *TBI MOTION* Metal Scraper

The scraper decreases the possibility of high temperature iron chip or dust entering the block.

Felt

Double-lip end seal is suitable for environment with high contamination. Felt lubricates the ball track of the rail extending the lifetime. This accessory is suitable for light rating load environment.

Oil Reservoir

After installation, oil reservoir can extend lubricating effect.

Table 2.2.17 Codes of Accessories

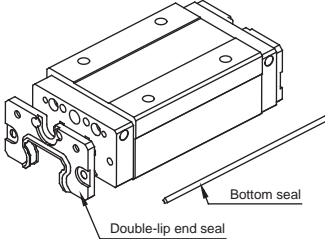
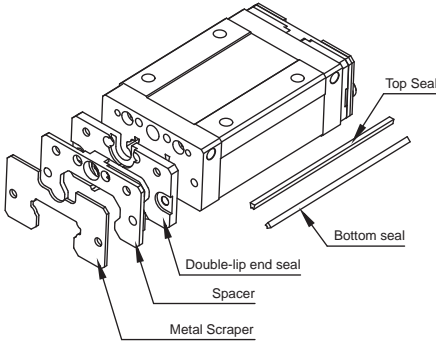
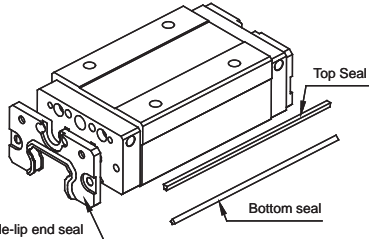
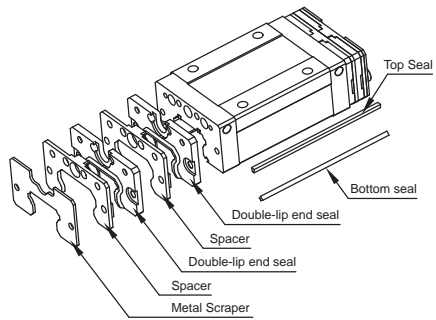
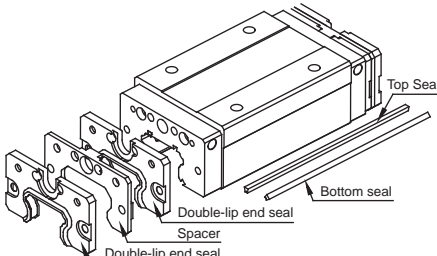
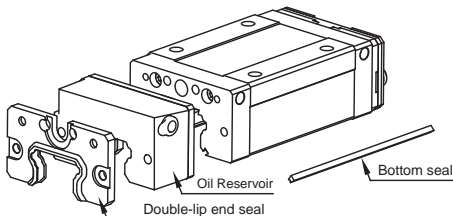
<p>XN (Double-lip end seals+Bottom seals)</p>	<p>SU (Double-lip end seals+Bottom seals+Top seals+Metal Scraper)</p>
 <p>Bottom seal</p> <p>Double-lip end seal</p>	 <p>Top Seal</p> <p>Bottom seal</p> <p>Double-lip end seal</p> <p>Spacer</p> <p>Metal Scraper</p>
<p>UN (Double-lip end seals+Bottom seals+Top seals)</p>	<p>SZ (Two Double-lip end seals+Bottom seals+Top seals+Metal Scraper)</p>
 <p>Top Seal</p> <p>Bottom seal</p> <p>Double-lip end seal</p>	 <p>Top Seal</p> <p>Bottom seal</p> <p>Double-lip end seal</p> <p>Spacer</p> <p>Double-lip end seal</p> <p>Spacer</p> <p>Metal Scraper</p>
<p>ZN (Two Double-lip end seals+Bottom seals+Top seals)</p>	<p>BN (Double-lip end seals+Bottom seals+Oil Reservoir)</p>
 <p>Top Seal</p> <p>Bottom seal</p> <p>Double-lip end seal</p> <p>Spacer</p> <p>Double-lip end seal</p>	 <p>Oil Reservoir</p> <p>Bottom seal</p> <p>Double-lip end seal</p>

※ After selection of different accessories increase the overall length of the slider, see table 2.2.18.

TBI MOTION LINEAR GUIDE

2-2 TRH / TRS / TRC International Standard Linear Guide

A

Linear Guide

WW (Double-lip end seals+Bottom seals+Felts)

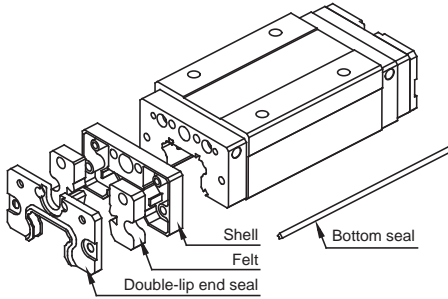

DU (Double-lip end seals+Bottom seals+Top seals+Felts+Metal Scraper)

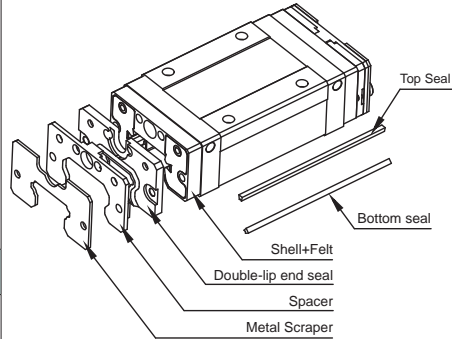

WU (Double-lip end seals+Bottom seals+Top Seals+Felts)

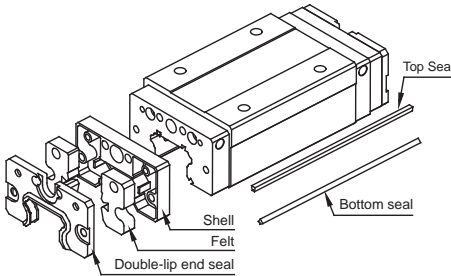

DZ (Two Double-lip end seals+Bottom seals+Top seals+Felts+Metal Scraper)

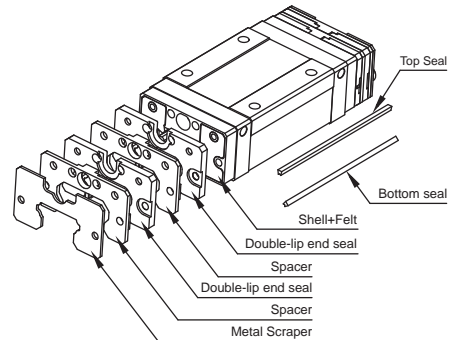

WZ (Two Double-lip end seals+Bottom seals+Top Seals+Felts)

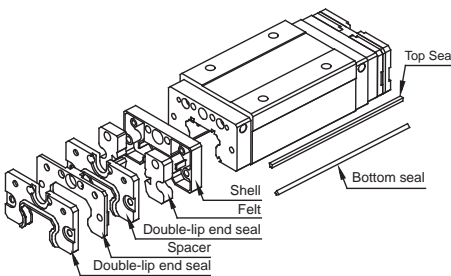

Table 2.2.18 TR Type Block Length of Accessories

Unit : mm

Two Double-lip end seals (ZN)								
Length of Block Code \ Type	TR15	TR20	TR25	TR30	TR35	TR45	TR55	TR65
S	47.9	58.4	65.6	76.4	84.7	-	-	-
N	64.5	TRS (77.3) TRH (84.6)	89.4	105.3	118	134.5	-	-
L	-	-	-	-	-	150	173	208
E	-	108.6	118.4	141	162	184	211.1	267.5

Double-lip end seals+Felt (WW, WU)								
Length of Block Code \ Type	TR15	TR20	TR25	TR30	TR35	TR45	TR55	TR65
S	51.8	60.9	68.7	78.9	87.2	-	-	-
N	68.4	TRS (79.8) TRH (87.1)	92.5	107.8	120.5	136	-	-
L	-	-	-	-	-	151.5	-	-
E	-	111.1	121.5	143.5	164.5	185.5	-	-

Two Double-lip end seals+Felt (WZ)								
Length of Block Code \ Type	TR15	TR20	TR25	TR30	TR35	TR45	TR55	TR65
S	59.4	69.9	77.1	87.9	96.2	-	-	-
N	76	TRS (88.8) TRH (96.1)	100.9	116.8	129.5	146	-	-
L	-	-	-	-	-	161.5	-	-
E	-	120.1	129.9	152.5	173.5	195.5	-	-

Double-lip end seals+Metal Scraper (SU)								
Length of Block Code \ Type	TR15	TR20	TR25	TR30	TR35	TR45	TR55	TR65
S	45.3	54.4	62.2	72.4	80.7	-	-	-
N	61.9	TRS (73.3) TRH (80.6)	86	101.3	114	129.5	-	-
L	-	-	-	-	-	145	167	202
E	-	104.6	115	137	158	179	205.1	261.5

TBI MOTION LINEAR GUIDE

2-2 TRH / TRS / TRC International Standard Linear Guide

Table 2.2.18 TR Type Block Length of Accessories

Unit : mm

Two Double-lip end seals+Metal Scraper (SZ)								
Length of Block Code \ Type	TR15	TR20	TR25	TR30	TR35	TR45	TR55	TR65
S	52.9	63.4	70.6	81.4	89.7	-	-	-
N	69.5	TRS (82.3) TRH (89.6)	94.4	110.3	123	139.5	-	-
L	-	-	-	-	-	155	178	213
E	-	113.6	123.5	146	167	189	216.1	272.5

Double-lip end seals+Felt+Metal Scraper (DU)								
Length of Block Code \ Type	TR15	TR20	TR25	TR30	TR35	TR45	TR55	TR65
S	56.8	65.9	73.7	83.9	92.2	-	-	-
N	73.4	TRS (84.8) TRH (92.1)	97.5	112.8	125.5	141	-	-
L	-	-	-	-	-	156.5	-	-
E	-	116.1	126.5	148.5	169.5	190.5	-	-

Two Double-lip end seals+Felt+Metal Scraper (DZ)								
Length of Block Code \ Type	TR15	TR20	TR25	TR30	TR35	TR45	TR55	TR65
S	64.4	74.9	82.1	92.9	101.2	-	-	-
N	81	TRS (93.8) TRH (101.1)	105.9	121.8	134.5	151	-	-
L	-	-	-	-	-	166.5	-	-
E	-	125.1	134.9	157.5	178.5	200.5	-	-

Double-lip end seals+Oil Reservoir (BN)								
Length of Block Code \ Type	TR15	TR20	TR25	TR30	TR35	TR45	TR55	TR65
S	55.8	66.4	73.2	83.4	91.7	-	-	-
N	72.4	TRS (85.3) TRH (92.6)	97	112.3	125	144	-	-
L	-	-	-	-	-	159.5	-	-
E	-	116.6	126	148	169	193.5	-	-

A

Linear Guide

Dust-proof Rails

Once the Linear Guide is operating in a cutting machine, dust and foreign matter that enter the Linear Guide may cause abnormal wear and shorten the service life.

Linear Guide rail mounting-hole cap

Chips and foreign matter clogging the mounting holes of a Linear Guide rail may enter the Linear Guide block. To prevent this situation, the mounting holes must be closed with dedicated caps, which must be installed to flush with the Linear Guide rail top surface. To insert a dedicated cap into a mounting hole, drive the cap in using a plastic hammer with a flat metal pad placed over the cap until it matches with the Linear Guide rail top surface. (Fig 2.2.15)

Rail with tapped holes

Fixing a rail with tapped hole is different from fixing a standard one. A major strength of it is the shape of the tapped hole ; dust and chippings would not enter. (Fig 2.2.15)

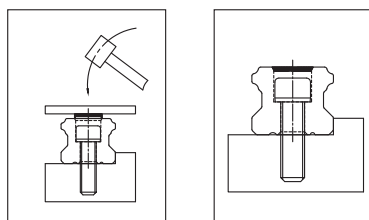

Fig 2.2.15 Dust-proof

■ 2-2-15 Friction

The figure showed in the chart is the maximum friction. (Table 2.2.20)

Table 2.2.20 End Cap friction rate

Unit : kgf

Model No.	End Cap friction rate (Max)
TR15	0.25
TR20	0.35
TR25	0.4
TR30	0.5
TR35	0.7
TR45	1.3
TR55	1.6
TR65	2

2-2 TRH / TRS / TRC International Standard Linear Guide

■ 2-2-16 Mounting-Surface Dimensional Tolerance

TR series Linear Guide is a Four-Way Equal-Load design, a slight dimensional error in the mounting surface can be absorbed by the self-adjusting capability, thus ensuring smooth linear motion. In the table below are the dimensional tolerances for the mounting surface of TR Linear Guide.

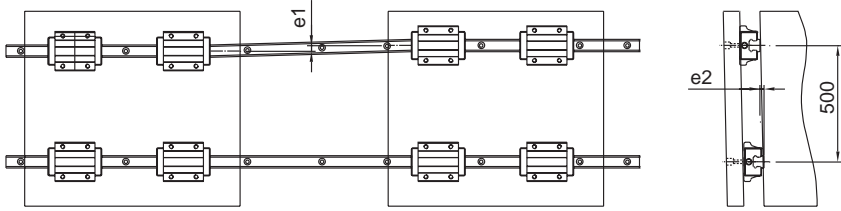

Fig 2.2.16

Table 2.2.21

Unit : μm

Model No.	Tolerance for Parallelism Between Two Axis(e1)					Tolerance for Parallelism Between Two Axis(e2)				
	Z3	Z2	Z1	Z0	ZF	Z3	Z2	Z1	Z0	ZF
TR15	-	-	18	25	35	-	-	85	130	190
TR20	-	18	20	25	35	-	50	85	130	190
TR25	15	20	22	30	42	60	70	85	130	195
TR30	20	27	30	40	55	80	90	110	170	250
TR35	22	30	35	50	68	100	120	150	210	290
TR45	25	35	40	60	85	110	140	170	250	350
TR55	34	45	50	70	98	130	170	210	300	410
TR65	42	55	60	80	105	150	200	250	350	460

2-3 TM Miniature Linear Guide

■ 2-3-1 The Characteristics of TM Series

Dust-Proof Design

The stainless bottom seal is the innovative new design of TM series. It prevents effectively the abnormal chips getting into the ball track from the bottom side of the block and keep the good running performance and extend the service life of the slider because the friction is low by keeping some small backlash between the slider and rail.

Standard end seals provide extreme protection from dust, metal scrapers to maintain long service life and shorten maintenance period. Unique low friction seal lips provide best smoothness and lower friction.

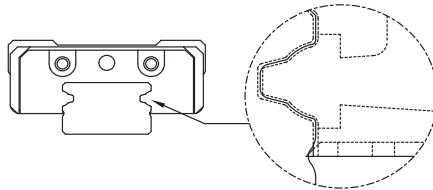

Fig 2.3.1

High Tensile Performance Stainless Steel Reinforcement Plate

Dual fully covered stainless steel plates design delivers the best coverage for plastic on each ends. Stainless steel screws are used to strength the rigidity, protection with end cap in order to sustain higher operational speed $V_{max} = 5 \text{ m/s}$, $\alpha_{max} = 300 \text{ m/s}$. When reinforcement plates and dust-proof seal is equipped to a Linear Block, they can function as a scraper.

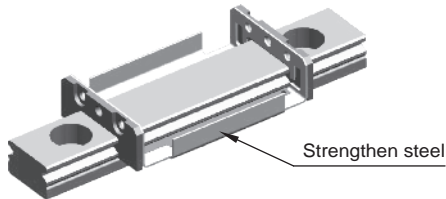

Fig 2.3.2

High Loading and Moment Capacity Performance

TM Miniature Linear Guide series uses two row circulation with Gothic 45° contact angle on the rail groove to achieve equal load capacity in four directions. Larger steel balls are used to enhance the loading and torsion resistance performance in limited space.

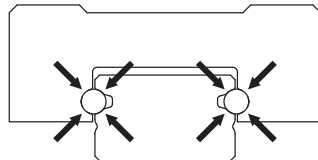

Fig 2.3.3 The Gothic 45° four-direction load structure

2-3 TM Miniature Linear Guide

2-3-2 The Structure of TM-series

Recirculation system : End cap + Recirculation tube + Ball retainer

Sealing system : Side + Bottom system

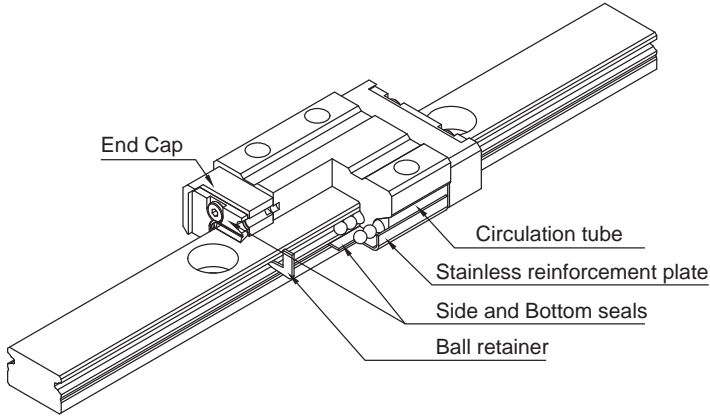

Fig 2.3.4

2-3-3 Accuracy

Miniature Linear Guide TM-series provides P, H, N three accuracy grades for customer to choose.

Table 2.3.1

	Accuracy (μm)		Precision P	High H	Normal N
	Tolerance of Height H		H	± 10	± 20
Variation of height with different block on same spot of the rail	Δ H		7	15	25
Tolerance of width W2		W2	± 15	± 25	± 40
Variation with width on different block on same spot of the rail	Δ W2		10	20	30

Speed

The maximum acceleration of TM-series can reach $V_{max} > 5 \text{ m/s}$, $a_{max} = 300 \text{ m/s}^2$ (60 m/s without preload).

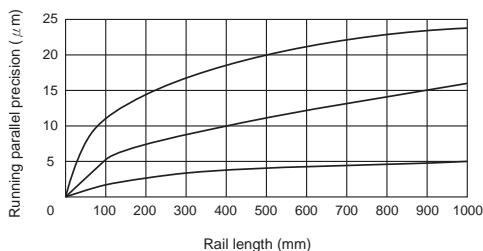

Fig 2.3.5 Running parallel precision slide relative to the rails datum

■ 2-3-4 Preload

Preload Value

Miniature Linear Guide TM-series offers three preloading level, ZF, Z0, Z1. A proper preload enhances performance on rigidity, precision, and torsion resistance; However, an improper preload shorten service life and increase friction.

Table 2.3.2 Table

Preload Grade	Pressure	Preload(μm)				Applications
		7	9	12	15	
ZF	Slight Clearance	+4~0	+4~0	+5~0	+6~0	Running smoothly
Z0	Zero Preload	+2~0	+2~0	+2~0	+3~0	Precision applications, Running smoothly
Z1	Light Preload	0~3	0~4	0~5	0~6	High steel, Precision applications, Running smoothly

Permissible Operational Temperature

The Miniature Linear Guide TM-series is sufficient to operate between $-40^{\circ}\text{C} \sim +80^{\circ}\text{C}$. For sudden temperature rise the temperature can reach up to $+100^{\circ}\text{C}$.

TBI MOTION LINEAR GUIDE

2-3 TM Miniature Linear Guide

2-3-5 Types of Lubrication

Grease

When a linear guide is well lubricated, the contact point between rail and rolling steel balls will be separated by 1 micro meter. Therefore, a good lubrication increases the service life of linear guide.

Clean room Lubrication

Suitable for low contamination environment.

Lubrication

General usage, ISO V32~68.

※If Special oil is required please contact *TBI MOTION*.

Table 2.3.3

Model	Lubrication amount (cc)	Model	Lubrication amount (cc)
TM07NN	0.3		
TM07NL	0.4		
TM09NN	0.4	TM09WN	0.4
TM09NL	0.6	TM09WL	0.6
TM012NN	0.9	TM012WN	0.9
TM012NL	1.3	TM012WL	1.3
TM015NN	1.4	TM015WN	1.4
TM015NL	2.0	TM015WL	2.0



2-3-6 Order Information

Customized Requirement :

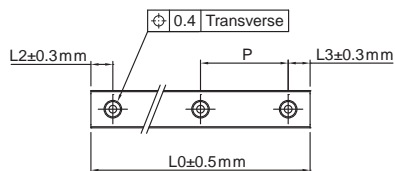

Table 2.3.4

Rail Length	Dimension			
	TM7	TM9	TM12	TM15
Pitch(mm)	15	20	25	40
Wide Pitch(mm)	—	30	40	40
L2, L3 min	3	4	4	4
L2, L3 max	10	20	20	35
Lmax	1300	1300	1300	1300

※If special dimension is required please contact *TBI MOTION*.

Height of Shoulder on Mounting Surface and Chamfer

Height of shoulder should be taken into consideration when installing a Linear Guide, if the block or rail is over-chamfered, the tip part has the possibility to effect the accuracy of Linear Guide, or if the height of shoulder is to high, it interferes the operation of block. Install the Linear Guide as suggested, the accuracy of Linear Guide can be maintained.

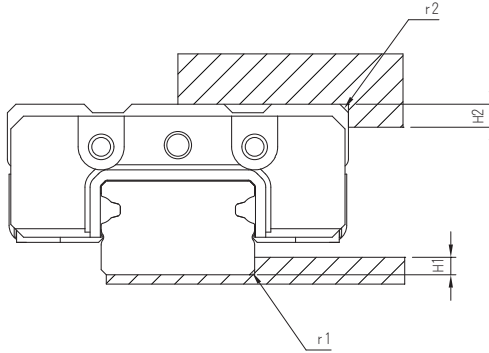

Table 2.3.5 Height of shoulder a chamfer

Model No.	Corner Radius of Mounting Surface r1	Corner Radius of Mounting Surface r2	Shoulder height on rail side H1	Shoulder height on rail side H2
TM07N	0.3	0.2	1	3
TM09N	0.3	0.3	1.7	3
TM12N	0.5	0.4	2.5	4
TM15N	0.5	0.5	2.5	5
TW09W	0.3	0.3	2.5	3
TW12W	0.5	0.5	3	4
TW15W	0.5	0.5	3	5

Table 2.3.6 Condition with Hexagonal Head Bolt

Model No.	Screw No.	Fasten Torque		
		Steel	Casting	Aluminum Alloy
TM07N	M2	57	39.2	29.4
TM09N	M3	186	127	98
TM12N	M3	186	127	98
TM15N	M3	186	127	98
TW09W	M3	186	127	98
TW12W	M4	392	274	206
TW15W	M4	392	274	206

TBI MOTION LINEAR GUIDE

2-3 TM Miniature Linear Guide

■ 2-3-7 Nominal Model Code of TM Type

Length of Block

Perform joint treatment when required lengths exceed 1300. Please contact TBI MOTION for detailed information.

T M 07 W L A - 2 - [] - 1000 - N A - Z0 - II K

① ② ③ ④ ⑤ ⑥ ⑦ ⑧ ⑨ ⑩ ⑪ ⑫ ⑬ ⑭

①	②	③	④
Nominal Model	Block Type	Dimension	Width of Rail
T	M : Mini X : Special	07, 09, 12, 15	N : Standard W : Wide

(Drawing will be provided for special item in order to distinguish the height of the rail.)

⑤	⑥	⑦
Length of Block	Material of Block	Quantity of Block
N : Standard L : Long	S : Stainless steel A : Alloy steel	(Mark 1 when there is only 1 runner block)

⑧	⑨	⑩	⑪
Accessory Code	Length of Rail	Accuracy Grade	Material of Rail
□ : Standard (End seal + Side seal)	Unit : mm	N : Normal H : High P : Precision	S : Stainless steel A : High Carbon steel

⑫	⑬	⑭
Preload	Two Sets per Axis	Rail Special Machining
ZF : Slight Clearance Z0 : No Preload Z1 : Light Preload	(No need to be marked when there is only one rail) II	K : Tapped-Hole Rail X : Rail with Special Machining

※ No symbol required when no plating is need.

TM-N Series Specifications

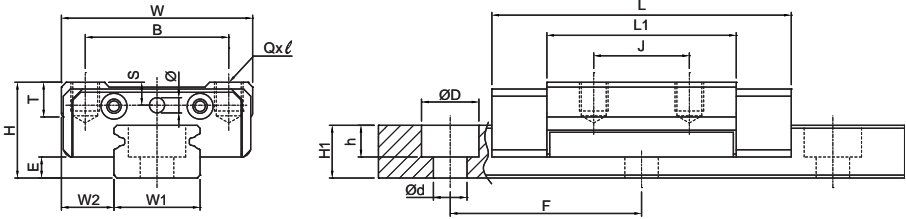

Model No.	Assembly (mm)			Rail(mm)								Block(mm)					
	H	W2	E	W	B	J	T	L	L1	Qxℓ	Ø	W1	H1	ØD	h	Ød	F
TM07NN	8	5	1.2	17	12	8	2.25	22.8	12.3	M2x2	1.3	7	4.7	4.2	2.3	2.4	15
TM07NL	8	5	1.2	17	12	13	2.25	30.8	20.3	M2x2	1.3	7	4.7	4.2	2.3	2.4	15
TM09NN	10	5.5	1.9	20	15	10	3.62	30.4	19.8	M3x3	1.3	9	5.5	6	3.3	3.5	20
TM09NL	10	5.5	1.9	20	15	16	3.62	40.7	30.1	M3x3	1.3	9	5.5	6	3.3	3.5	20
TM12NN	13	7.5	2.7	27	20	15	4.54	34.4	20.6	M3x3.5	1.3	12	7.5	6	4.5	3.5	25
TM12NL	13	7.5	2.7	27	20	20	4.54	46.9	33.1	M3x3.5	1.3	12	7.5	6	4.5	3.5	25
TM15NN	16	8.5	3.7	32	25	20	5.86	42.4	27	M3x5	1.3	15	9.5	6	4.5	3.5	40
TM15NL	16	8.5	3.7	32	25	25	5.86	59.4	44	M3x5	1.3	15	9.5	6	4.5	3.5	40

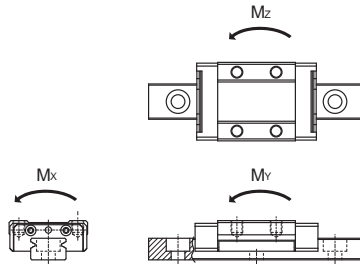

Model No.	Load Rating (kgf)		Static Permissible Moment					Weight	
			Mx(kgf-mm)	My(kgf-mm)		Mz(kgf-mm)		Rail (kg/m)	Rail (kg/m)
	C	Co		Single Block	Single Block	Double Block	Single Block		
TM07NN	144	204	745	232	3,234	232	3,234	0.005	0.21
TM07NL	220	374	1,367	849	7,261	849	7,261	0.009	
TM09NN	220	374	1,713	849	7,117	849	7,117	0.013	0.32
TM09NL	299	579	2,648	2,099	14,174	2,099	14,174	0.020	
TM12NN	381	536	3,269	1,094	12,391	1,094	12,391	0.024	0.61
TM12NL	555	919	5,604	3,437	26,857	3,437	26,857	0.039	
TM15NN	581	834	6,336	2,316	23,096	2,316	23,096	0.048	1
TM15NL	860	1,459	11,088	7,527	52,908	7,527	52,908	0.080	

TBI MOTION LINEAR GUIDE

2-1 The Types of TBI MOTION Linear Guide

TM-W Series Specifications

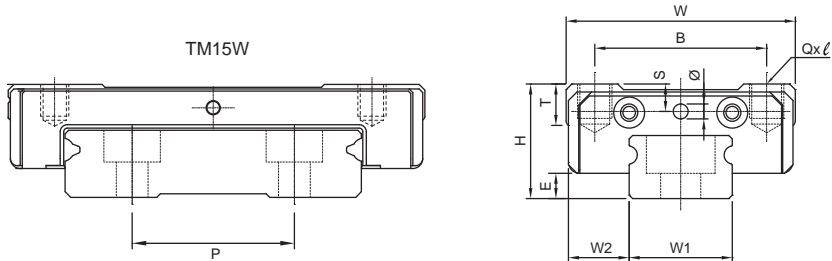

Model No.	Assembly (mm)			Rail(mm)							Block(mm)							
	H	W2	E	W	B	J	T	L	L1	Qxℓ	Ø	W1	H1	ØD	h	Ød	F	P
TM09WN	12	6	3	30	21	12	4	39.1	26.7	M3x3	1.3	18	7.3	6	4.5	3.5	30	
TM09WL	12	6	3	30	23	24	4	50.7	38.3	M3x3	1.3	18	7.3	6	4.5	3.5	30	
TM12WN	14	8	3.5	40	28	15	4.5	46.2	29	M3x3.5	1.3	24	8.5	8	4.5	4.5	40	
TM12WL	14	8	3.5	40	28	28	4.5	61.2	44	M3x3.5	1.3	24	8.5	8	4.5	4.5	40	
TM15WN	16	9	3.6	60	45	20	4.8	55.1	38.5	M4x4.5	1.3	42	9.5	8	4.5	4.5	40	23
TM15WL	16	9	3.6	60	45	35	4.8	74.2	57.6	M4x4.5	1.3	42	9.5	8	4.5	4.5	40	23

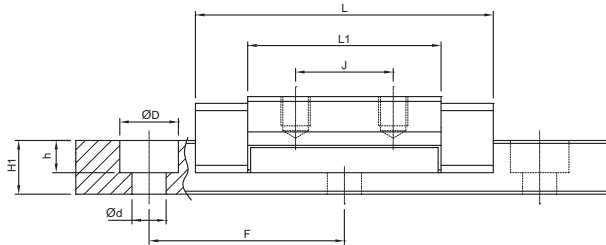

Model No.	Load Rating (kgf)		Static Permissible Moment					Weight	
			Mx(kgf-mm)	My(kgf-mm)		Mz(kgf-mm)		Rail (kg/m)	Rail (kg/m)
	C	Co		Single Block	Single Block	Double Block	Single Block		
TM09WN	208	368	4,645	1,621	12,205	1,621	12,205	0.03	0.97
TM09WL	260	509	7,123	3,905	23,411	3,905	23,411	0.043	
TM12WN	313	530	10,190	2,864	23,153	2,864	23,153	0.05	1.47
TM12WL	415	796	15,748	7,083	46,164	7,083	46,164	0.076	
TM15WN	517	856	26,387	5,459	42,543	5,459	42,543	0.116	2.85
TM15WL	686	1,283	41,779	14,144	87,256	14,144	87,256	0.175	